



The Ultimate in Fall Protection

Instructions for the following series products:

100% Tie-off SRL

Model Numbers: (see inside back cover)

USER INSTRUCTION MANUAL
100% TIE-OFF TALON™ SELF RETRACTING
LIFELINES

This manual is intended to meet the Manufacturer's Instructions as required by ANSI Z359.1, CSA Z259.2.2 (Type 1), and should be used as part of an employee training program as required by OSHA.



Figure 1 - 100% Tie-off Talon Self Retracting Lifeline

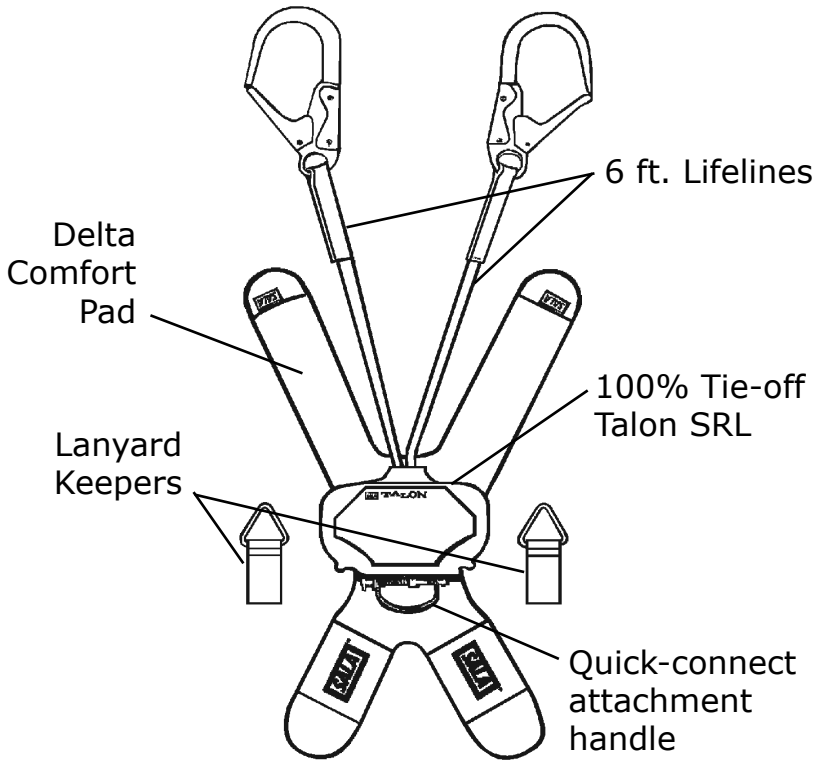

WARNING: This product is part of a personal fall arrest system. The user must read and follow the manufacturer's instructions for each component of the system. These instructions must be provided to the user of this product. The user must read and understand these instructions before using this product. Manufacturer's instructions must be followed for proper use and maintenance of this product. Alteration or misuse of this product, or failure to follow instructions may result in serious injury or death.

IMPORTANT: If you have questions about the use, care, or suitability of this equipment for your application contact DBI-SALA.

IMPORTANT: Before using this equipment record the product identification information from the ID label in the inspection and maintenance log in section 9.0 of this manual.

DESCRIPTIONS

Talon 100% Tie-off Series Self Retracting Lifeline: See Figure 1. Includes quick connect attachment handle, 6 foot nylon web lifeline, Delta™ comfort pad, and two lanyard keepers.

1.0 APPLICATIONS

1.1 PURPOSE: DBI-SALA self retracting lifelines (SRL’s) are components of a personal fall arrest system (PFAS). These SRL’s may be used to provide continuous fall protection while ascending, descending, or moving laterally.

FALL PROTECTION: The SRL is used as part of a complete personal fall arrest system. Personal fall arrest systems typically include a full body harness, anchorage connector, and SRL.

1.2 LIMITATIONS:

- A. PERSONAL FALL ARREST SYSTEM:** Personal fall arrest system components used with the SRL must meet the system requirements specified in sections 2.1 and 2.2.
- B. ANCHORAGE STRUCTURE:** The structure to which the SRL is attached must be selected according to the limitations and strength requirements specified in this manual. See section 2.4 for more information.
- C. FALL CLEARANCE:** There must be sufficient clearance below the user to arrest a fall before the user strikes the ground or other obstruction. Refer to section 3.2 for more information.
- D. CAPACITY:** The SRL is designed for use by persons with a combined weight (clothing, tools) of no more than 310 lbs or 420 lbs. No more than one person may be connected to the SRL at any time.

31202015, 3102015, 3102016, 3102017:	420 lbs
All Other Models:	310 lbs

- E. LOCKING SPEED:** Use of the SRL in confined spaces, on slowly shifting material (sand or grain), or on a low pitched roof may not allow sufficient lock-up speed to arrest a fall. A clear fall path is required to safely arrest a fall.
- F. NORMAL OPERATION:** Normal operation will allow the full length of the lifeline to extend and retract without hesitation or creating a slack line condition as the worker moves at normal speeds. If a fall occurs, a speed sensing brake system will activate, stopping the fall and absorbing much of the energy created. If a fall has been arrested, the SRL must be removed from service and inspected. See section 5.0. Sudden or quick movements should be avoided during normal work operation as this may cause the SRL to lock-up.

- G. ENVIRONMENTAL HAZARDS:** Use of the SRL in hazardous environments may require additional precautions to reduce the possibility of injury to the user or damage to the personal fall arrest system. Hazards may include, but are not limited to; heat, caustic or corrosive chemicals, high voltage power lines, explosive or toxic gases, moving machinery, sharp edges, overhead objects that may fall and strike the lifeline.
- H. TRAINING:** The SRL is intended to be installed and used by persons trained in its application and use. See section 4.

- 1.3** Refer to national standards, including ANSI Z359.1 and applicable local, state, and federal (OSHA) requirements governing this equipment for more information on this equipment and associated system components.

2.0 SYSTEM REQUIREMENTS

- 2.1 COMPATIBILITY OF COMPONENTS:** DBI-SALA equipment is designed for use with DBI-SALA approved components and subsystems only. Substitutions or replacements made with non-approved components or subsystems may jeopardize compatibility of equipment and may effect the safety and reliability of the complete system. Personal fall arrest systems must meet applicable local, state, and federal (OSHA) requirements. A full body harness must be used with the Talon SRL.

- 2.2 COMPATIBILITY OF CONNECTORS:** Connectors are considered to be compatible with connecting elements when they have been designed to work together in such a way that their sizes and shapes do not cause their gate mechanisms to inadvertently open regardless of how they become oriented. Contact DBI-SALA if you have any questions about compatibility.

Connectors (hooks, carabiners, and D-rings) must be capable of supporting at least 5,000 lbs. (22.2kN). Per ANSI Z359.1, connector gates must be able to withstand a load of 3,600 lbs (16 kN): the face of the gate must withstand 3,600 lbs (16 kN); the side of the gate must withstand 3,600 lbs (16 kN), and the minor axis for a snap hook or carabiner must withstand 3,600 lbs (16 kN), except those with captive eyes. Connectors must be compatible with the anchorage or other system components. Do not use equipment that is not compatible. Non-compatible connectors may unintentionally disengage. See Figure 2. Connectors must be compatible in size, shape, and strength. Self locking snap hooks and carabiners are required by ANSI Z359.1 and OSHA.

- 2.3 MAKING CONNECTIONS:** Only use self-locking snap hooks and carabiners with this equipment. Only use connectors that are suitable to each application. Ensure all connections are compatible in size, shape and strength. Do not use equipment that is not compatible. Ensure all connectors are fully closed and locked.

Figure 2 - Unintentional Disengagement (Roll-out)

If the connecting element that a snap hook or carabiner attaches to is undersized or irregular in shape, a situation could occur where the connecting element applies a force to the gate of the snap hook or carabiner. This force may cause the gate (of either a self-locking or a non-locking snap hook) to open, allowing the snap hook or carabiner to disengage from the connecting point.

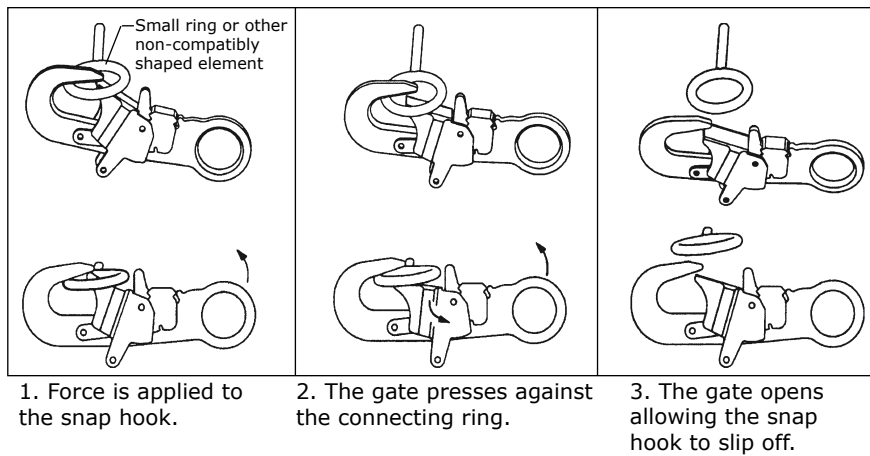

DBI-SALA connectors (snap hooks and carabiners) are designed to be used only as specified in each product's user's instructions. See Figure 3 for inappropriate connections. DBI-SALA snap hooks and carabiners should not be connected:

- A. To a D-ring to which another connector is attached.
- B. In a manner that would result in a load on the gate.

NOTE: Large throat opening snap hooks should not be connected to standard size D-rings or similar objects which will result in a load on the gate if the hook or D-ring twists or rotates. Large throat snap hooks are designed for use on fixed structural elements such as rebar or cross members that are not shaped in a way that can capture the gate of the hook.

- C. In a false engagement, where features that protrude from the snap hook or carabiner catch on the anchor and without visual confirmation seems to be fully engaged to the anchor point.
- D. To each other.
- E. Directly to webbing or rope lanyard or tie-back (unless the manufacturer's instructions for both the lanyard and connector specifically allow such a connection).
- F. To any object which is shaped or dimensioned such that the snap hook or carabiner will not close and lock, or that roll-out could occur.
- G. In a manner that does not allow the connector to align with the fall arrest device (i.e., SRL) while under load.

Figure 3 - Inappropriate Connections

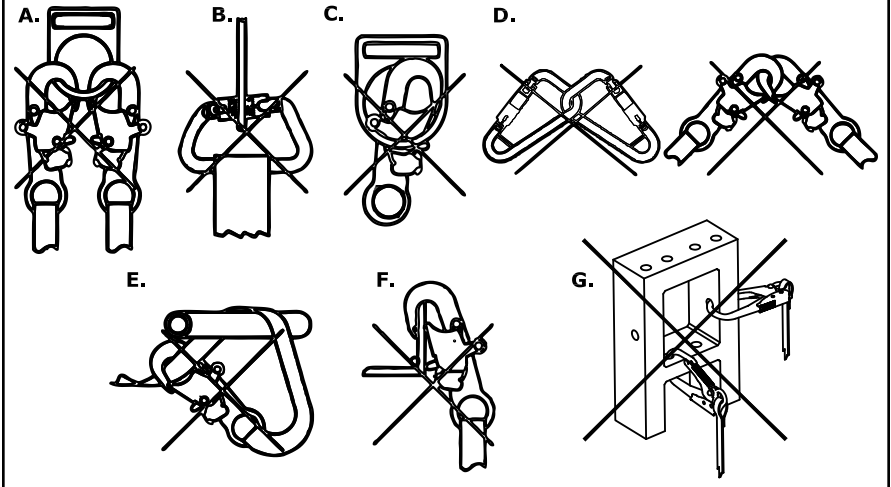

2.4 ANCHORAGE STRUCTURE: The anchorage to which the SRL is attached must be capable of sustaining static loads in the directions applied by the personal fall arrest system of at least 3,600 lbs. with certification of a qualified person, or 5,000 lbs. without certification. See ANSI Z359.1 for certification requirements. When more than one personal fall arrest system is attached to the same structure, the strength requirements stated above must be multiplied by the number of personal fall arrest systems attached to the structure.

- **From OSHA 1910.66 and 1926.500:** Anchorages used for attachment of a personal fall arrest system shall be independent of any anchorage being used to support or suspend platforms, and must support at least 5,000 lbs. per user attached, or be designed, installed, and used as part of a complete personal fall arrest system which maintains a safety factor of at least two, and is supervised by a qualified person.

2.5 USING THE SRL WITH A HORIZONTAL SYSTEM: The SRL and horizontal system components must be compatible. Horizontal systems must be designed and installed under the supervision of a qualified person.

3.0 INSTALLATION AND USE

WARNING: Do not alter or intentionally misuse this equipment. Consult DBI-SALA when using this equipment in combination with components or subsystems other than those described in this manual. Some subsystem and component combinations may interfere with the operation of this equipment. Use caution when using this equipment around moving machinery, electrical hazards, chemical hazards, and sharp edges; or under overhead materials that may fall onto the lifeline. Failure to heed this warning may result in equipment malfunction, injury, or death.

WARNING: Consult your doctor if there is reason to doubt your fitness to safely absorb the shock from a fall arrest. Age and fitness can seriously affect your ability to withstand a fall. Pregnant women and minors must not use this equipment.

3.1 BEFORE EACH USE: Inspect the SRL according to section 5.0.

3.2 PLAN your personal fall arrest system before installing and using this equipment. Consider all factors affecting your safety during use of this equipment.

A. ANCHORAGE: Select a rigid anchorage point capable of supporting at least 5,000 lbs. See section 2.4. Select an anchorage location that will avoid free fall and swing fall hazards. To prevent an increased free fall distance do not work above the anchorage.

B. FREE FALL: Your personal fall arrest system must be rigged such that an anchor point is above your harness attachment element (dorsal D-ring) when in use. Avoid working where your lifeline may cross or tangle with that of another worker. Do not allow the lifeline to pass under your arms or between your feet. Never clamp, knot, or otherwise prevent the lifeline from retracting. Do not allow slack in your lifeline. Do not lengthen the SRL by connecting a lanyard or other component.

C. SWING FALLS: Swing falls occur when the anchorage point is not directly above the point where a fall occurs. See Figure 4. The force of striking an object in a swing fall may cause serious injury. In a swing fall, the total vertical fall distance will be greater than if the user had fallen directly below the anchorage point, thus increasing the total free fall distance and the area required to safely arrest

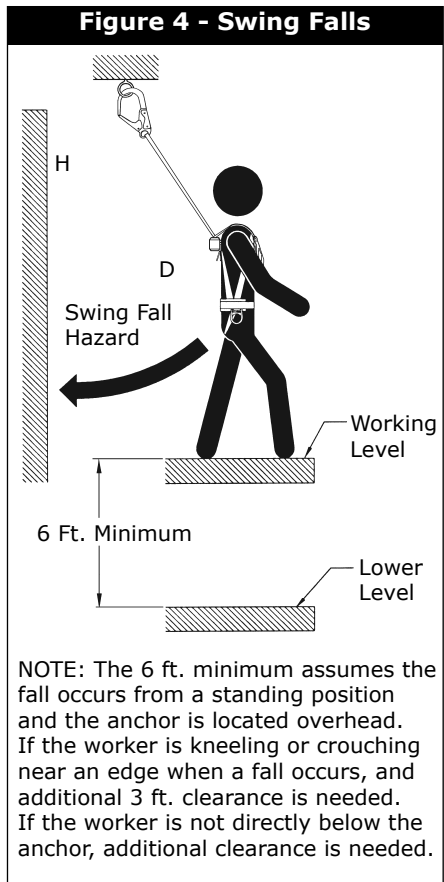

the user. The SRL will activate regardless of its orientation relative to the user. Minimize swing falls by working as directly below the anchorage point as possible. Never permit a swing fall if injury could occur. If a swing fall situation exists in your application contact DBI-SALA before proceeding.

- D. FALL CLEARANCE:** Ensure adequate clearance exists in your fall path to prevent striking an object. A minimum of 6 feet from the working level to the lower level or nearest obstruction is recommended. See Figure 4.
- E. SHARP EDGES:** Avoid working where the lifeline will be in contact with or abrade against unprotected sharp edges. Provide protection for the lifeline when possible. An energy absorbing component can sometimes be added in-line to further protect the worker. Compatibility and total fall distance must be considered if this is done. Contact DBI-SALA before using an in-line energy absorbing component or lanyard with an SRL.
- F. AFTER A FALL:** Equipment which has been subjected to fall arrest forces must be removed from service for inspection. See section 5.0.
- G. RESCUE:** If a fall occurs, the employer must have a rescue plan and the ability to implement a rescue.

3.3 ATTACHING THE DELTA COMFORT PADS TO A FULL BODY HARNESS:

Lay the harness on a work surface with the dorsal D-ring facing up. Slide the Comfort Pad underneath the webbing with the longer arms going up underneath the shoulder straps and the shorter arms extending downward toward the leg straps. Open the hook-and-loop fastening of each arm of the pad and tuck the harness webbing between the folds of the pad, then reseal the hook and loop fastening and close the snaps. See Figure 5.

NOTE: The Comfort Pads are optional and are not necessary to the use of the 100% Tie-off SRL

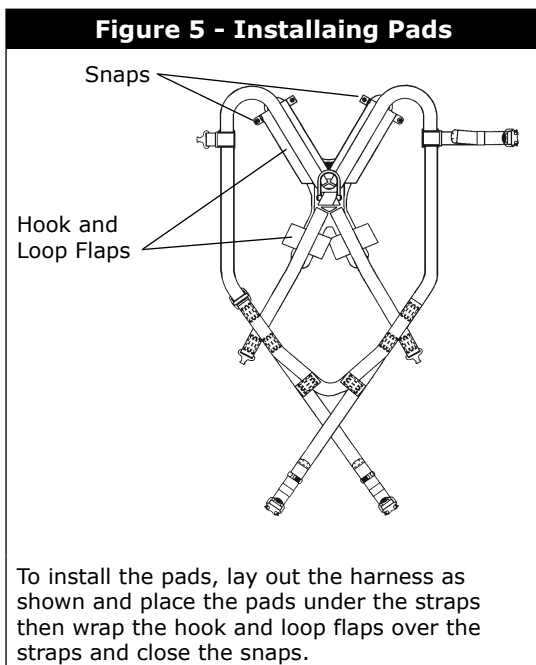

3.4 ATTACHING THE SRL TO A FULL BODY HARNESS: See Figure 6.

Step 1. Open the Quick-Connect Handle:, Depress the Locking Lever (A) and then pull the Locking Pin (B) out to release the Handle. Once released, swing the Handle open.

Step 2. Insert the Quick-Connect Handle under the Harness Webbing: Insert the Handle (C) under the two Web Straps (D) that pass through the base of the Dorsal D-Ring at a point adjacent to the base of the D-Ring. Slide the Handle under both Web Straps until it extends out the opposite side of the straps.

IMPORTANT: *The handle of the SRL must pass underneath the web in the same manner as the existing D-ring. See Figure 7.*

Step 3. Close the Quick-Connect Handle: Swing the Handle (C) closed and align the hole in Handle with the end of the Locking Pin (B). Release the Locking Lever (A) so the Locking Pin springs closed into the hole in the Handle.

WARNING: *Ensure the locking pin fully engages the handle and the locking lever is in the locked position.*

Step 4. Secure Twin-Leg Talon SRLs with the Hook and Loop Straps: Wrap the Hook and Loop Straps (E) extending from the sides of the Twin-Leg Talon underneath the Harness Shoulder Straps and fasten them together to hold the SRL in the proper position.

3.5 USING THE 100% TIE-OFF SRL: When connected to the SRL the worker is free to move about within the recommended working area. The lifeline should extend and retract without hesitation or creating a slack line condition as the worker moves at normal speeds. If a fall occurs the SRL will lock and arrest the fall. When disconnecting from the SRL keep the lifeline under control as it recoils back into the device.

100% TIE-OFF SRL CONSIDERATIONS: Commonly known as 100% tie-off, "Y" type, twin leg SRL, these energy absorbing devices can be used to provide continuous fall protection while ascending, descending, or moving laterally. With one leg attached to the anchor structure, the worker can move to a new location, attach the second unused leg, and disconnect original attached leg. This procedure is repeated until the work location is reached. Other practices that must be followed in order to use a 100% tie-off type SRL safely include:

- Connection of both lanyard legs to separate anchorage points is acceptable See Figure 8.
- Never connect more than one person to a "Y" type SRL at a time. See Figure 9.

- Do not allow the lifelines to become tangled or twisted together as this may prevent them from retracting.
- Do not allow any lanyard to pass under arms or between legs during use.

Figure 6 - Using the Attachment Handle

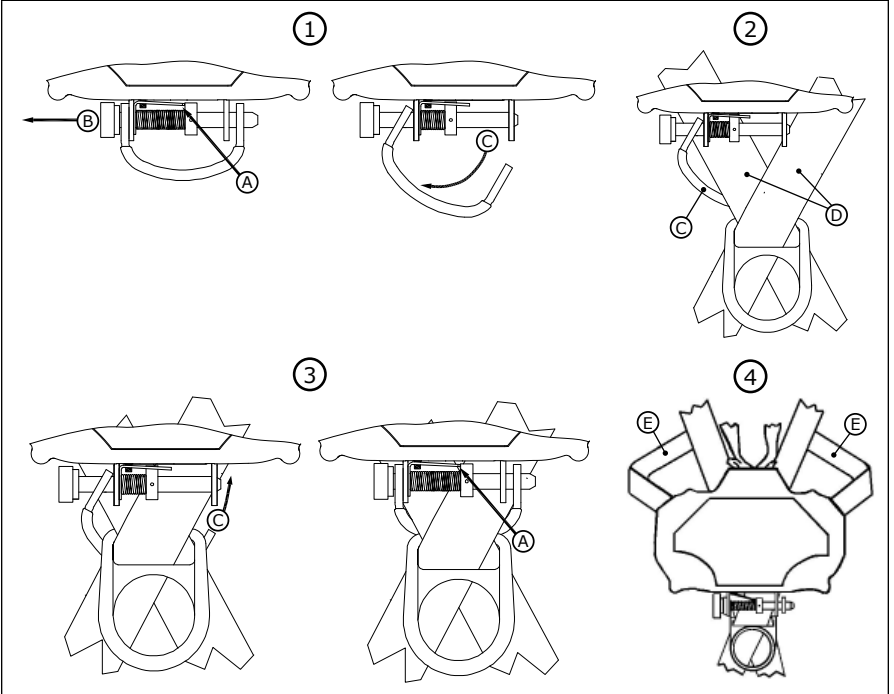

Figure 7



Figure 8

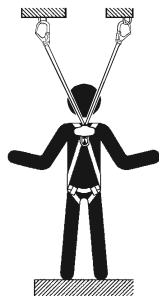
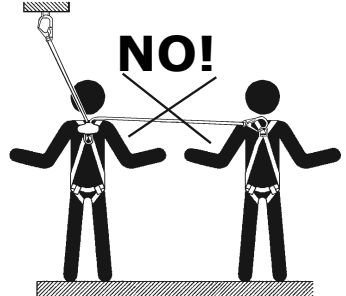
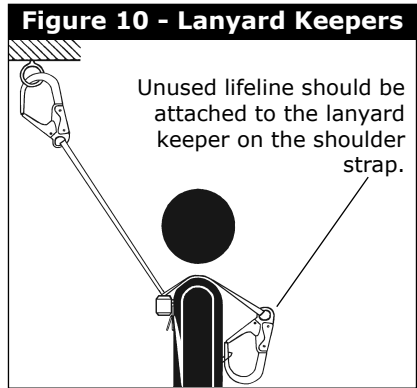

Figure 9



3.6 LANYARD KEEPERS: Two lanyard keepers are supplied with the 100% Tie-off SRL. One of these lanyard keepers should be attached to each shoulder strap. Pull open the hook and loop attachment straps and wrap the straps around the shoulder strap at a convenient location, then close the hook and loop attachments. While the lifelines are not in use they should be attached to the lanyard keepers to keep them secured in a convenient location. See Figure 10.



3.7 IMPACT INDICATOR: See Figure 11. The SRL incorporates an impact indicator in the lifeline. The lifeline web is folded over and stitched with red thread. The stitched fold will pull out at approximately 450 lbs. If the red stitching is intact the SRL has not been impacted. If the red stitching is broken and the fold torn apart, the SRL has been impacted and must be removed from service and returned to an authorized service center for repair.

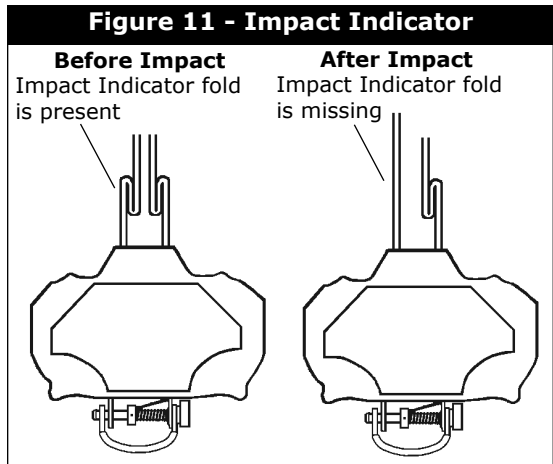

4.0 TRAINING

4.1 It is the responsibility of all users of this equipment to understand these instructions, and to be trained in the correct installation, use, and maintenance of this equipment. These individuals must be aware of the consequences of improper installation or use of this equipment. This user manual is not a substitute for a comprehensive training program. Training must be provided on a periodic basis to ensure proficiency of the users.

WARNING: Training must be conducted without exposing the trainee to a fall hazard. Training must be repeated on a periodic basis.

5.0 INSPECTION

5.1 FREQUENCY:

- **Before Each Use:** OSHA 1910.66, OSHA 1926.502 and ANSI Z359.1 requires an inspection of equipment before each use. See sections 5.2, 5.3, and 5.4 for inspection guidelines.
- **Annually:** ANSI Z359.1 requires a formal inspection of the SRL be completed by a competent person other than the user. More frequent inspections by a competent person may be required based on the nature and severity of workplace conditions affecting the equipment and the modes of use and exposure time of the equipment. See sections 5.2, 5.3, and 5.4 for inspection guidelines. Record results in the inspection and maintenance log in section 9.0.
- **After a Fall Arrest:** Inspect impact indicator according to section 5.2, and the entire SRL according to sections 5.3 and 5.4.

5.2 IMPACT INDICATOR: To inspect the impact indicator, find the fold in the lifeline stitched with red thread, as shown in Figure 10. If the red stitching is broken and the fold torn apart, the SRL has been impacted and must be removed from service and returned to an authorized service center for repair. Do not restitch the fold.

WARNING: *If the SRL has been subjected to fall arrest or impact forces it must be removed from service and returned to an authorized service center for repair.*

5.3 INSPECTION STEPS:

- Step 1.** Check for loose screws and bent or damaged parts.
- Step 2.** Check the housing for distortion, cracks, or other damage. Ensure the anchorage point is not damaged or distorted.
- Step 3.** The lifeline must fully extend and retract smoothly with no hesitation or slack line condition.
- Step 4.** Ensure the device locks when the lifeline is pulled sharply. Lock-up should be positive, with no slipping.
- Step 5.** All labels must be present and fully legible. See section 8.0.
- Step 6.** Check for corrosion on the entire unit.
- Step 7.** Check the lifeline for cuts, burns, chemical damage, or severely abraded areas. The lifeline must not be damaged.

- Step 8.** Inspect the Quick-Connect Handle and Locking Lever for damage and proper operation (see Figure 12). Make sure the Locking Pin (A) closes and locks in closed position when the Locking Lever (B) is released. Make sure the Locking Lever is held in position by the Plastic Nubs (C) on the SRL Housing Halves.
- Step 9.** Check the connecting hooks or carabiners for damage, distortion, or corrosion, and working condition.
- Step 10.** Inspect each component of the personal fall arrest system according to manufacturer's instructions.
- Step 11.** Record the inspection results in the inspection and maintenance log in section 9.0.

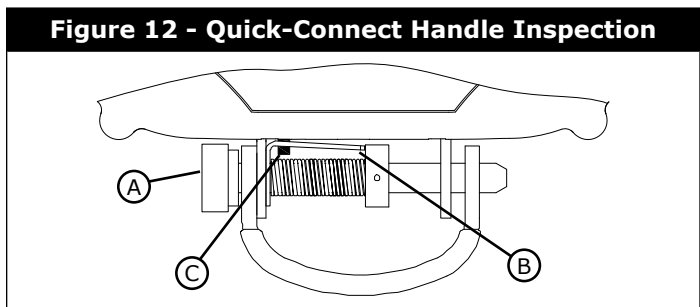

- 5.4** If the inspection reveals an unsafe or defective condition, remove the SRL from service and contact an authorized service center for repair.

NOTE: Only DBI-SALA or parties authorized in writing may make repairs to this equipment.

6.0 MAINTENANCE, SERVICING, AND STORAGE

6.1 MAINTENANCE:

- A. HOUSING:** Periodically clean the exterior of the SRL with water and a mild detergent. Position the SRL so water can drain out. Clean labels as required.
- B. LIFELINE:** Clean the lifeline with water and a mild detergent. Rinse and thoroughly air dry. Do not force dry with heat. An excessive build-up of dirt or other contaminants may prevent the lifeline from fully retracting, causing a potential free fall hazard. Return the SRL to an authorized service center for lifeline replacement if necessary.
- C. PERSONAL FALL ARREST SYSTEM COMPONENTS:** Clean and store associated system components according to manufacturer's instructions.

6.2 SERVICING: Do not disassemble the SRL. Do not lubricate any part of the SRL. Additional maintenance and servicing must be performed by an authorized service center. A return authorization number must be issued by DBI-SALA. See section 5.1 for servicing frequency.

6.3 STORAGE: Store the SRL in a cool, dry, and clean environment, out of direct sunlight. Avoid storing the SRL in areas where chemical vapors exist. Thoroughly inspect the SRL after extended storage.

7.0 SPECIFICATIONS

7.1 PERFORMANCE SPECIFICATIONS:

- **Capacity:** One User Only;

31202015, 3102015, 3102016, 3102017:	75 lbs - 420 lbs
All Other Models:	75 lbs - 310 lbs

- **Working Range:** 2.5 ft. to 6 feet
- **Maximum Arresting Force:** When tested in accordance with ANSI Z359.1;

31202015, 3102015, 3102016, 3102017:	310 lbs - 420 lbs	1,350 lbs
All Other Models:	75 lbs - 310 lbs	900 lbs

- **Average Locking Speed:** 4.5 ft./second
- **Maximum Arresting Distance:** 42 inches

7.2 PHYSICAL SPECIFICATIONS:

- **Overall Dimensions, Quick-Connect Attachment Handle Models (LxWxH):** 7.5 x 3.8 x 2.6 inches
- **Materials:**
 - Housing:** Nylon Plastic
 - Cable Drum:** Glass filled nylon
 - Internal Components:** Heat-treated Alloy Steel and Stainless Steel
 - Lifeline:** 1 inch nylon web
 - Anchorage Handle:** Steel, locking type, quick-connect
 - Hooks:** 5,000 lb. minimum tensile strength
- **Weight:** 5.4 lbs. (3102000 model)

7.3 PATENTS AND REQUIREMENTS:

- **Patents:** Pending
- **Meets:** ANSI Z359.1, OSHA and CSA Z259.2.2 (type 1) requirements.

8.0 LABELING

8.1 THE FOLLOWING LABELS MUST BE PRESENT AND FULLY LEGIBLE:

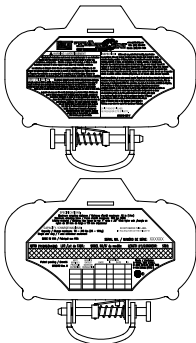

Warning & Use Label

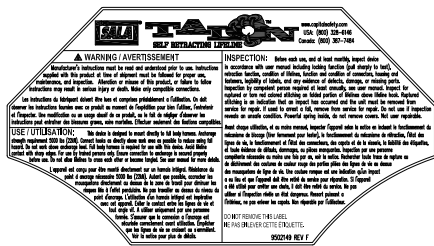

**ID Label
(420 lbs Capacity)**

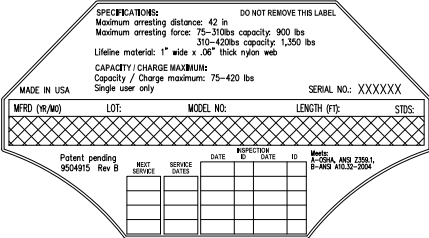

**ID Label
(310 lbs Capacity)**

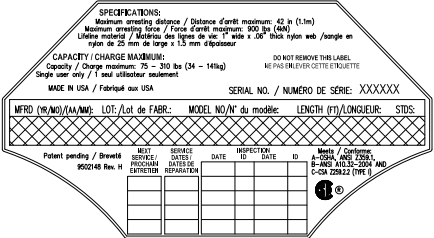

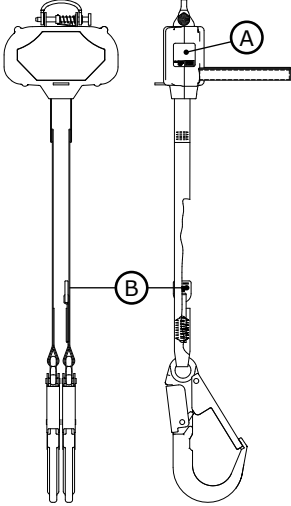

(A) i-Safe Label



This product is i-Safe enabled and contains an electronic tag that can be read by compatible readers – providing inspection logs, inventory management and other safety information.
Ce produit est validé dans i-Safe et contient une rondelle d'identification électronique qui peut être lue par des lecteurs compatibles – en fournissant des registres d'inspection, de l'informations sur la gestion des stocks et d'autre information relative à la protection.
9502313 Rev. C

(B) i-Safe RFID Tag



IMPORTANT: The i-Safe Identification Number on the RFID Tag is for purposes of electronic record keeping with the i-Safe system. Where the Serial Number is printed on the product's ID Label (illustrated above), the i-Safe Identification Number and Serial Number may be different numbers.

9.0 INSPECTION AND MAINTENANCE LOG

SERIAL NUMBER: _____

MODEL NUMBER: _____

DATE PURCHASED: _____ DATE FIRST USED: _____

INSPECTION DATE	INSPECTION ITEMS NOTED	CORRECTIVE ACTION	MAINTENANCE PERFORMED
Approved By: _____			
Approved By: _____			
Approved By: _____			
Approved By: _____			
Approved By: _____			
Approved By: _____			
Approved By: _____			
Approved By: _____			
Approved By: _____			
Approved By: _____			
Approved By: _____			
Approved By: _____			
Approved By: _____			
Approved By: _____			

MODEL NUMBERS

This instruction applies to the following Models:

3101998	3102001	3102004	3102008	3102016	3102100
3101999	3102002	3102005	3102009	3102017	3102101
3102000	3102003	3102006	3102014	3102019	3102102
3102000C	3102003C	3102007	3102015	3102020	3102115

Additional Model Numbers may appear on the next printing of these instructions.

LIMITED LIFETIME WARRANTY

Warranty to End User: D B Industries, Inc., dba CAPITAL SAFETY USA ("CAPITAL SAFETY") warrants to the original end user ("End User") that its products are free from defects in materials and workmanship under normal use and service. This warranty extends for the lifetime of the product from the date the product is purchased by the End User, in new and unused condition, from a CAPITAL SAFETY authorized distributor. CAPITAL SAFETY'S entire liability to End User and End User's exclusive remedy under this warranty is limited to the repair or replacement in kind of any defective product within its lifetime (as CAPITAL SAFETY in its sole discretion determines and deems appropriate). No oral or written information or advice given by CAPITAL SAFETY, its distributors, directors, officers, agents or employees shall create any different or additional warranties or in any way increase the scope of this warranty. CAPITAL SAFETY will not accept liability for defects that are the result of product abuse, misuse, alteration or modification, or for defects that are due to a failure to install, maintain, or use the product in accordance with the manufacturer's instructions.

CAPITAL SAFETY'S WARRANTY APPLIES ONLY TO THE END USER. THIS WARRANTY IS THE ONLY WARRANTY APPLICABLE TO OUR PRODUCTS AND IS IN LIEU OF ALL OTHER WARRANTIES AND LIABILITIES, EXPRESSED OR IMPLIED. CAPITAL SAFETY EXPRESSLY EXCLUDES AND DISCLAIMS ANY IMPLIED WARRANTIES OF MERCHANTABILITY OR FITNESS FOR A PARTICULAR PURPOSE, AND SHALL NOT BE LIABLE FOR INCIDENTAL, PUNITIVE OR CONSEQUENTIAL DAMAGES OF ANY NATURE, INCLUDING WITHOUT LIMITATION, LOST PROFITS, REVENUES, OR PRODUCTIVITY, OR FOR BODILY INJURY OR DEATH OR LOSS OR DAMAGE TO PROPERTY, UNDER ANY THEORY OF LIABILITY, INCLUDING WITHOUT LIMITATION, CONTRACT, WARRANTY, STRICT LIABILITY, TORT (INCLUDING NEGLIGENCE) OR OTHER LEGAL OR EQUITABLE THEORY.



The Ultimate in Fall Protection

CSG USA & Latin America

3833 SALA Way
Red Wing, MN 55066-5005
Toll Free: 800.328.6146
Phone: 651.388.8282
Fax: 651.388.5065
solutions@capitalsafety.com

CSG Canada

260 Export Boulevard
Mississauga, ON L5S 1Y9
Phone: 905.795.9333
Toll-Free: 800.387.7484
Fax: 888.387.7484
info.ca@capitalsafety.com

CSG Northern Europe

5a Merse Road
North Moons, Moat
Reditch, Worcestershire, UK
B98 9HL
Phone: + 44 (0)1527 548 000
Fax: + 44 (0)1527 591 000
csgne@capitalsafety.com

CSG EMEA (Europe, Middle East, Africa)

Le Broc Center
Z.I. 1ère Avenue
5600 M B.P. 15 06511
Carros
Le Broc Cedex
France
Phone: + 33 4 97 10 00 10
Fax: + 33 4 93 08 79 70
information@capitalsafety.com

CSG Australia & New Zealand

95 Derby Street
Silverwater
Sydney NSW 2128
AUSTRALIA
Phone: +(61) 2 8753 7600
Toll-Free : 1 800 245 002 (AUS)
Toll-Free : 0800 212 505 (NZ)
Fax: +(61) 2 87853 7603
sales@capitalsafety.com.au

CSG Asia

Singapore:
Rm 1406, Enterprise Road
Singapore 627666
Phone: +65 - 65587758
Fax: +65 - 65587058
inquiry@capitalsafety.com

Shanghai:
Rm 1406, China Venturetech Plaza
819 Nan Jing Xi Rd,
Shanghai 200041, P R China
Phone: +86 21 62539050
Fax: +86 21 62539060

www.capitalsafety.com

