



The Ultimate in Fall Protection

Instructions for the following series products:

**SYNTHETIC ROPE HORIZONTAL LIFELINE**

See the last pages for specific model numbers

## **User Instruction Manual Synthetic Rope Horizontal Lifeline System**

*This manual is intended to be used as part of an employee training program as required by OSHA.*





**Figure 1 - Typical Installation**

**Typical Horizontal Lifeline Installation**

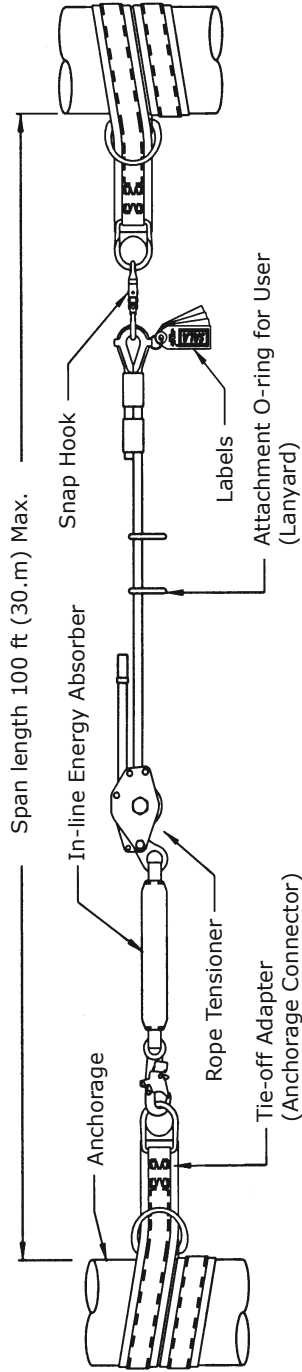

**WARNING:** *This product is part of a personal fall arrest system. The user must follow the manufacturer's instructions for each component of the system. These instructions must be provided to the user of this equipment. The user must read and understand these instructions before using this equipment. Manufacturer's instructions must be followed for proper use and maintenance of this equipment. Alterations or misuse of this equipment, or failure to follow instructions, may result in serious injury or death.*

**IMPORTANT:** *If you have questions on the use, care, or suitability of this equipment for your application, contact DBI-SALA.*

**IMPORTANT:** *Record the product identification information from the ID label in the inspection and maintenance log in section 9.0 of this manual.*

## **1.0 APPLICATION**

- 1.1 PURPOSE:** The Sayflite Synthetic Rope Horizontal Lifeline System is designed for use as an anchoring means for one or two persons. Use the Sayflite Horizontal Lifeline System where horizontal mobility and fall protection are required.
- 1.2 LIMITATIONS:** The following limits apply to the installation and use of the Sayflite Synthetic Rope Horizontal Lifeline System. Other limitations may apply:

**IMPORTANT:** *OSHA regulations state that horizontal lifelines shall be installed and used under the supervision of a qualified person (see below for definition) as part of a complete personal fall arrest system that maintains a safety factor of at least two.*

**QUALIFIED PERSON:** *An individual with a recognized degree or professional certificate, and extensive knowledge and experience in the subject field, who is capable of design, analysis, evaluation, and specification in the subject work, project, or product. Refer to OSHA 1910.66, 1926.32, and 1926.502.*

- A. HORIZONTAL LIFELINE SPAN:** The maximum span distance is 100 feet. The span length must be reduced when clearance is limited. See section 3.2 for clearance information.
- B. ANCHORAGES:** The Sayflite horizontal lifeline must be installed on anchorages that meet the requirements specified in section 2.4.
- C. SYSTEM CAPACITY:** The maximum capacity of the Sayflite horizontal lifeline is two persons. The maximum weight of each person, including tools and clothing, is 310 lbs. (141kg).
- D. CONNECTING SUBSYSTEM:** Each person's connecting subsystem must limit fall arrest forces to 900 lbs. (4kN) or less. See section 2.5.

**E. FREE FALL:** Rig and use the personal fall arrest system such that the maximum potential free fall does not exceed Government regulatory and subsystem manufacturer's requirements. See section 3.0 and subsystem manufacturer's Instructions for more information.

**F. SWING FALLS:** See Figure 2. Swing falls occur when the anchorage point is not directly overhead. The force of striking an object in a swing fall may cause serious injury or death. Minimize swing falls by working as directly below the anchorage point as possible. Do not permit a swing fall if injury could occur. Swing falls will significantly increase the clearance required when a self retracting lifeline or other variable length connecting subsystem is used. If a swing fall situation exists in your application, contact DBI-SALA before proceeding.

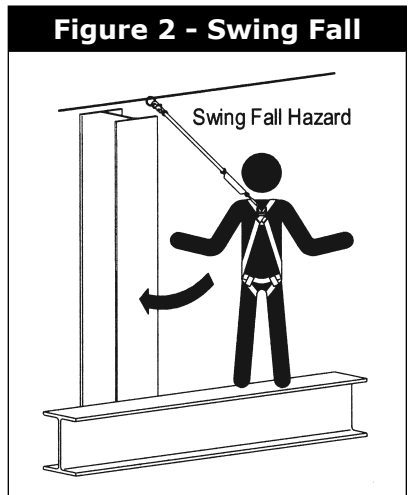

**G. FALL CLEARANCE:** There must be sufficient clearance below the worker to arrest a fall before striking the lower level or obstruction. See section 3.2 for required clearance information.

**H. BODY SUPPORT:** A full body harness must be used with the Synthetic Rope Horizontal Lifeline System.

**I. ENVIRONMENTAL HAZARDS:** Use of this equipment in areas with environmental hazards may require additional precautions to reduce the possibility of injury to the user or damage to the equipment. Hazards may include, but are not limited to; heat, chemicals, corrosive environments, high voltage power lines, gases, moving machinery, and sharp edges. Contact DBI-SALA if you have questions about using this equipment where environmental hazards exist.

**J. TRAINING:** This equipment must be installed and used by persons trained in its correct application and use. See section 4.0.

**1.3 APPLICABLE STANDARDS:** Refer to national standards, including ANSI Z359.1, local, state, and federal (OSHA 1910.66 and 1926.502) requirements for more information on personal fall arrest systems and associated components. In Canada, see the Z259 group of CSA standards.

## 2.0 SYSTEM REQUIREMENTS

- 2.1 PERSONAL FALL ARREST SYSTEM COMPONENTS:** The Sayflite horizontal lifeline must be used with DBI-SALA approved components and subsystems. Non-approved components may be incompatible, and could affect the safety and reliability of the complete system. Personal fall arrest components used with this system must meet all applicable OSHA and ANSI requirements. A full body harness must be used with this system.
- 2.2 PERSONAL FALL ARREST SYSTEM CONNECTORS:** Connectors used to attach to the attachment O-ring on the horizontal lifeline (hooks, carabiners, D-rings) must support at least 5,000 lbs. Connectors and attachment elements must be compatible in size, shape, and strength. Non-compatible connectors may unintentionally disengage (roll-out). Do not use non-locking connectors with this system.
- 2.3 ANCHORAGE CONNECTORS:** Connectors used to attach the horizontal lifeline to end anchors must be compatible with the connection point. The connection must be positive; and, with connecting elements, capable of sustaining a 5,000 lbs. (22.2kN) load without failure.
- 2.4 STRUCTURE LOAD:** Structural anchorage points must be rigid, and capable of supporting at least 3,600 lbs. (16kN) along the axis of the horizontal lifeline. Anchorages must also support at least 3,600 lbs. (16kN) applied in all potential directions of fall arrest that are perpendicular to the axis of the horizontal lifeline. See Figure 3.
- WARNING:** Anchorages must be rigid. Large deformations of the anchorage will affect system performance, and may increase the required fall clearance below the system, which could result in serious injury or death.
- 2.5 CONNECTING SUBSYSTEM:** The connecting subsystem is the portion of the personal fall arrest system that is used to connect between the horizontal lifeline subsystem and harness fall arrest attachment element. The connecting subsystem must limit forces applied to the horizontal lifeline to 900 lbs. (4kN) or less.

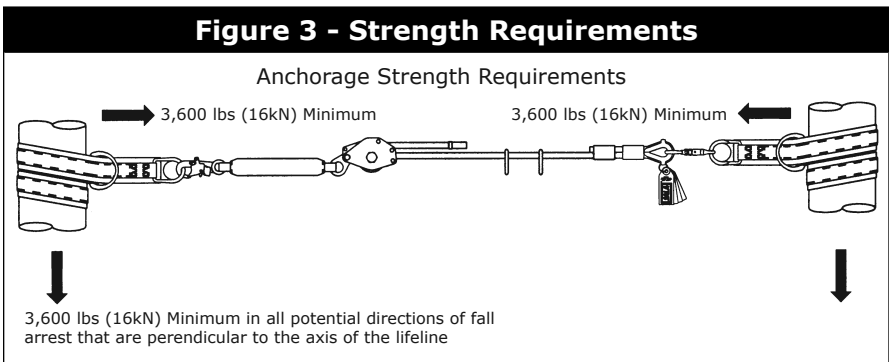

## 3.0 OPERATION AND USE

**WARNING:** Do not alter or intentionally misuse this equipment. Consult DBI-SALA when using this equipment in combination with components or subsystems other than those described in this manual. Some subsystem and component combinations may interfere with the operation of this equipment. Use caution when using this equipment around moving machinery, electrical hazards, chemical hazards, and sharp edges.

**WARNING:** Consult your doctor if there is reason to doubt your fitness to absorb the impact from a fall arrest. Age and fitness can affect your ability to withstand fall arrest forces. Pregnant women and minors must not use this system.

- 3.1 BEFORE EACH USE** inspect this equipment according to section 5.0. Do not use this equipment if inspection reveals an unsafe or defective condition. Plan your use of the fall protection system prior to exposing workers to dangerous situations. Consider all factors affecting your safety before using this system.
- A.** Read and understand all manufacturer's instructions for each component of the personal fall arrest system. All DBI-SALA harnesses and connecting subsystems are supplied with separate user instructions. Keep all instructions for future reference.
  - B.** Review sections 1.0 and 2.0 to ensure system limitations and other requirements have been adhered to. Review applicable information regarding system clearance criteria, and ensure changes have not been made to the system installation (i.e. length) or occurred at the job site that could affect the required fall clearance. Do not use the system if changes are required.
- 3.2 SYSTEM INSTALLATION:** Figure 1 shows a typical Sayline horizontal lifeline installation. When using an energy absorbing lanyard to connect to the system, the end anchorages must be located at a height which will limit the free fall to 6 feet (1.8m). When using a self retracting lifeline (SRL) to connect to the system, the end anchorages must be located above the user. The SRL, when fully retracted, must be above the harness attachment level. The horizontal lifeline system should be positioned at a level that will minimize free fall while allowing ease of use. The horizontal lifeline should be positioned near the work location to minimize swing fall hazards. The connecting subsystem length should be kept as short as possible to reduce the potential free fall and required clearance distance. Both anchorages must be installed at approximately the same elevation, so that the horizontal lifeline system is not sloped more than 5°.
- Step 1.** Determine the locations of the end anchorages and evaluate their strengths in accordance with section 2.4. Determine the span length and evaluate the required clearance using Figures 4, 5, or 6 and Tables 1, 2 or 3.

## Figure 4 - Clearance: Single Worker with Energy Absorbing Lanyard

### Clearance Evaluation for One Worker Connected to the HLL with a DBI-SALA Energy Absorbing Lanyard

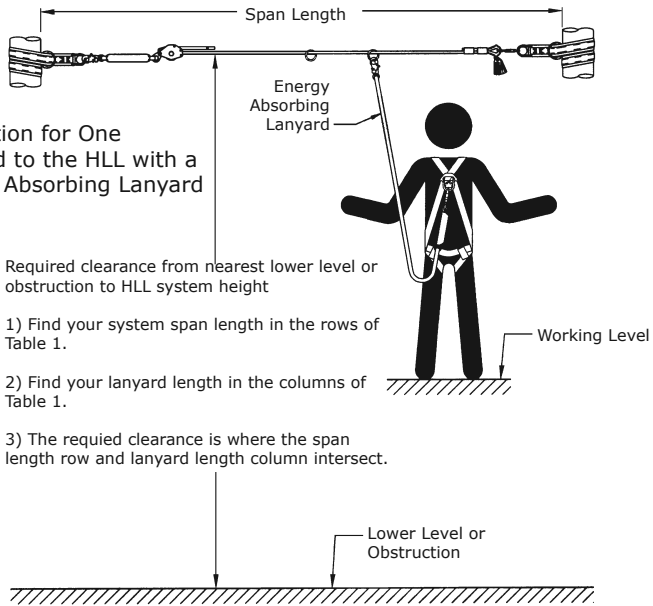

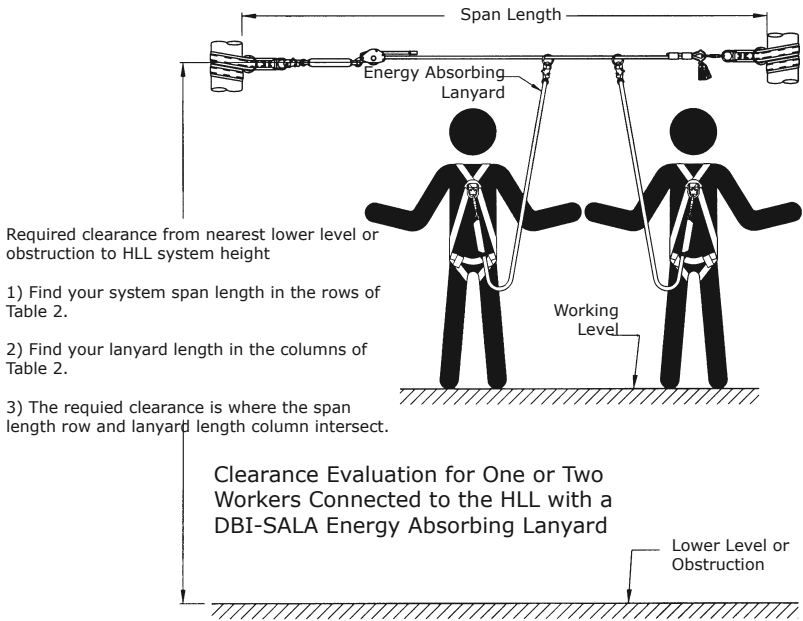

**Table 1 - Required Clearance for One Worker Connected to the System with a DBI-SALA Energy Absorbing Lanyard (See Figure 4)**

Span length in feet	Length of Energy Absorbing Lanyard in feet								
	3 (.91)	4 (1.22)	5 (1.52)	6 (1.83)	7 (2.13)	8 (2.44)	9 (2.74)	10 (3.1)	
0-10 (0-3.05)	16'-1" (4.90)	17'-1" (5.20)	18'-1" (5.51)	19'-1" (5.82)	20'-1" (6.12)	21'-1" (6.43)	22'-1" (6.73)	23'-1" (7.04)	
10-15 (3.05-4.57)	16'-3" (4.95)	17'-3" (5.26)	18'-3" (5.56)	19'-3" (5.87)	20'-3" (6.12)	21'-3" (6.48)	22'-3" (6.78)	23'-3" (7.09)	
15-20 (4.57-6.10)	16'-5" (5.00)	17'-5" (5.31)	18'-5" (5.61)	19'-5" (5.92)	20'-5" (6.27)	21'-5" (6.53)	22'-5" (6.83)	23'-5" (7.14)	
20-25 (6.10-7.62)	16'-7" (5.06)	17'-7" (5.36)	18'-7" (5.66)	19'-7" (5.97)	20'-7" (6.27)	21'-7" (6.58)	22'-7" (6.88)	23'-7" (7.19)	
25-30 (7.62-9.14)	16'-9" (5.11)	17'-9" (5.41)	18'-9" (5.72)	19'-9" (5.97)	20'-9" (6.33)	21'-9" (6.63)	22'-9" (6.93)	23'-9" (7.24)	
30-35 (9.14-10.67)	17'-6" (5.33)	18'-6" (5.64)	19'-6" (5.94)	20'-6" (6.25)	21'-6" (6.55)	22'-6" (6.86)	23'-6" (7.16)	24'-6" (7.47)	
35-40 (10.67-12.19)	18'-3" (5.56)	19'-3" (5.87)	20'-3" (6.17)	21'-3" (6.48)	22'-3" (6.78)	23'-3" (7.09)	24'-3" (7.39)	25'-3" (7.70)	
40-45 (12.19-13.72)	18'-11" (5.77)	19'-11" (6.07)	20'-11" (6.38)	21'-11" (6.68)	22'-11" (6.99)	23'-11" (7.29)	24'-11" (7.60)	25'-11" (7.90)	
45-50 (13.72-15.24)	19'-6" (5.94)	20'-6" (6.25)	21'-6" (6.55)	22'-6" (6.86)	23'-6" (7.16)	24'-6" (7.47)	25'-6" (7.77)	26'-6" (8.08)	
50-55 (15.2-16.76)	20'-2" (6.15)	21'-2" (6.45)	22'-2" (6.76)	23'-2" (7.06)	24'-2" (7.37)	25'-2" (7.67)	26'-2" (7.98)	27'-2" (8.28)	
55-60 (16.76-18.29)	20'-10" (6.35)	21'-10" (6.66)	22'-10" (6.96)	23'-10" (7.26)	24'-10" (7.57)	25'-10" (7.87)	26'-10" (8.18)	27'-10" (8.48)	
60-65 (18.29-19.81)	21'-5" (6.53)	22'-5" (6.83)	23'-5" (7.14)	24'-5" (7.44)	25'-5" (7.75)	26'-5" (8.05)	27'-5" (8.36)	28'-5" (8.66)	
65-70 (19.81-21.34)	22'-1" (6.73)	23'-1" (7.04)	24'-1" (7.34)	25'-1" (7.65)	26'-1" (7.95)	27'-1" (8.26)	28'-1" (8.56)	29'-1" (8.87)	
70-75 (21.34-22.86)	22'-8" (6.91)	23'-8" (7.21)	24'-8" (7.52)	25'-8" (7.82)	26'-8" (8.13)	27'-8" (8.43)	28'-8" (8.74)	29'-8" (9.04)	
75-80 (22.86-24.38)	23'-4" (7.11)	24'-4" (7.42)	25'-4" (7.72)	26'-4" (8.03)	27'-4" (8.33)	28'-4" (8.64)	29'-4" (8.94)	30'-4" (9.25)	
80-85 (24.38-25.91)	24'-0" (7.32)	25'-0" (7.62)	26'-0" (7.93)	27'-0" (8.23)	28'-0" (8.53)	29'-0" (8.84)	30'-0" (9.14)	31'-0" (9.45)	
85-90 (25.91-27.43)	24'-7" (7.49)	25'-7" (7.80)	26'-7" (8.10)	27'-7" (8.41)	28'-7" (8.71)	29'-7" (9.02)	30'-7" (9.32)	31'-7" (9.63)	
90-95 (27.43-28.96)	25'-3" (7.70)	26'-3" (8.00)	27'-3" (8.31)	28'-3" (8.61)	29'-3" (8.92)	30'-3" (9.22)	31'-3" (9.53)	32'-3" (9.83)	
95-100 (28.96-30.48)	25'-10" (7.87)	26'-10" (8.18)	27'-10" (8.48)	28'-10" (8.79)	29'-10" (9.09)	30'-10" (9.40)	31'-10" (9.70)	32'-10" (10.01)	

Meters are shown in parenthesis

## Figure 5 - Clearance: Two Workers with Energy Absorbing Lanyards

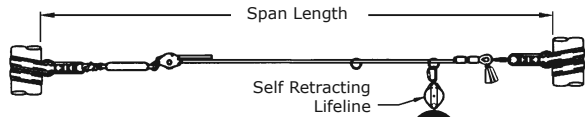

**Table 2 - Required Clearance for Two Workers Connected to the System with a DBI-SALA Energy Absorbing Lanyard (See Figure 5)**

Span length in feet	Length of Energy Absorbing Lanyard in feet							
	3 (.91)	4 (1.22)	5 (1.52)	6 (1.83)	7 (2.13)	8 (2.44)	9 (2.74)	10 (3.1)
0-10 (0-3.05)	16'-5" (5.00)	17'-5" (5.31)	18'-5" (5.61)	19'-5" (5.92)	20'-5" (6.27)	21'-5" (6.53)	22'-5" (6.83)	23'-5" (7.14)
10-15 (3.05-4.57)	17'-5" (5.31)	18'-5" (5.61)	19'-5" (5.92)	20'-5" (6.27)	21'-5" (6.53)	22'-5" (6.83)	23'-5" (7.14)	24'-5" (7.44)
15-20 (4.57-6.10)	18'-5" (5.61)	19'-5" (5.92)	20'-5" (6.27)	21'-5" (6.53)	22'-5" (6.83)	23'-5" (7.14)	24'-5" (7.44)	25'-5" (7.75)
20-25 (6.10-7.62)	19'-4" (5.89)	20'-4" (6.20)	21'-4" (6.50)	22'-4" (6.81)	23'-4" (7.11)	24'-4" (7.42)	25'-4" (7.72)	26'-4" (8.03)
25-30 (7.62-9.14)	20'-4" (6.20)	21'-4" (6.50)	22'-4" (6.81)	23'-4" (7.11)	24'-4" (7.42)	25'-4" (7.72)	26'-4" (8.03)	27'-4" (8.33)
30-35 (9.14-10.67)	21'-7" (6.58)	22'-7" (6.88)	23'-7" (7.19)	24'-7" (7.49)	25'-7" (7.80)	26'-7" (8.10)	27'-7" (8.41)	28'-7" (8.71)
35-40 (10.67-12.19)	22'-9" (6.93)	23'-9" (7.24)	24'-9" (7.54)	25'-9" (7.85)	26'-9" (8.15)	27'-9" (8.46)	28'-9" (8.76)	29'-9" (9.07)
40-45 (12.19-13.72)	23'-10" (7.26)	24'-10" (7.57)	25'-10" (7.87)	26'-10" (8.18)	27'-10" (8.48)	28'-10" (8.79)	29'-10" (9.09)	30'-10" (9.40)
45-50 (13.72-15.24)	24'-11" (7.60)	25'-11" (7.90)	26'-11" (8.20)	27'-11" (8.51)	28'-11" (8.81)	29'-11" (9.12)	30'-11" (9.42)	31'-11" (9.73)
50-55 (15.2-16.76)	26'-0" (7.93)	27'-0" (8.23)	28'-0" (8.53)	29'-0" (8.84)	30'-0" (9.14)	31'-0" (9.45)	32'-0" (9.75)	33'-0" (10.06)
55-60 (16.76-18.29)	27'-2" (8.28)	28'-2" (8.59)	29'-2" (8.89)	30'-2" (9.20)	31'-2" (9.50)	32'-2" (9.80)	33'-2" (10.11)	34'-2" (10.41)
60-65 (18.29-19.81)	28'-3" (8.61)	29'-3" (8.92)	30'-3" (9.22)	31'-3" (9.53)	32'-3" (9.83)	33'-3" (10.14)	34'-3" (10.44)	35'-3" (10.74)
65-70 (19.81-21.34)	29'-4" (8.94)	30'-4" (9.25)	31'-4" (9.55)	32'-4" (9.86)	33'-4" (10.16)	34'-4" (10.47)	35'-4" (10.77)	36'-4" (11.07)
70-75 (21.34-22.86)	30'-5" (9.27)	31'-5" (9.58)	32'-5" (9.88)	33'-5" (10.19)	34'-5" (10.49)	35'-5" (10.80)	36'-5" (11.10)	37'-5" (11.41)
75-80 (22.86-24.38)	31'-6" (9.60)	32'-6" (9.91)	33'-6" (10.21)	34'-6" (10.52)	35'-6" (10.82)	36'-6" (11.13)	37'-6" (11.43)	38'-6" (11.74)
80-85 (24.38-25.91)	32'-7" (9.93)	33'-7" (10.24)	34'-7" (10.54)	35'-7" (10.85)	36'-7" (11.15)	37'-7" (11.46)	38'-7" (11.76)	39'-7" (12.07)
85-90 (25.91-27.43)	33'-8" (10.26)	34'-8" (10.57)	35'-8" (10.87)	36'-8" (11.18)	37'-8" (11.48)	38'-8" (11.79)	39'-8" (12.09)	40'-8" (12.40)
90-95 (27.43-28.96)	34'-9" (10.59)	35'-9" (10.90)	36'-9" (11.20)	37'-9" (11.51)	38'-9" (11.81)	39'-9" (12.12)	40'-9" (12.42)	41'-9" (12.73)
95-100 (28.96-30.48)	35'-10" (10.92)	36'-10" (11.23)	37'-10" (11.54)	38'-10" (11.84)	39'-10" (12.14)	40'-10" (12.45)	41'-10" (12.75)	42'-10" (13.06)

Meters are shown in parenthesis

## Figure 6 - Clearance: One or Two Workers with SRLs



Required clearance from nearest lower level or obstruction to working level

- 1) Find your system span length in the rows of Table 3.
- 2) Find the number of workers to be connected to the system in the columns of Table 3.
- 3) The required clearance is where the span length row and number of workers column intersect.

### Clearance Evaluation for One or Two Workers Connected to the HLL with a DBI-SALA Self Retracting Lifeline

**WARNING:** This information only applies when the SRL is directly overhead and above the level of the harness attachment point and the user is standing.

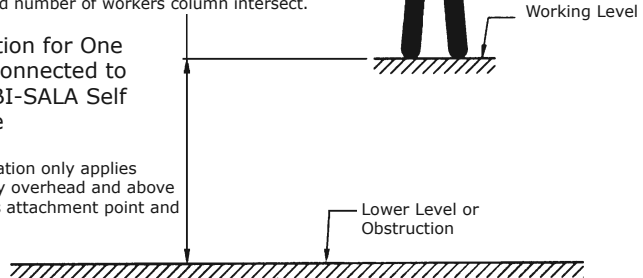

**Table 3 - Required Clearance for One or Two Workers Connected to the System with a DBI-SALA Self Retracting Lifeline (See Figure 6).**

<b>Span Length in feet</b>	<b>Required Clearance Below Working Level for One Worker</b>	<b>Required Clearance Below Working Level for Two Workers</b>
0-10 (0-3.05)	7'-11" (2.41)	8'-11" (2.72)
10-15 (3.05-4.57)	8'-2" (2.49)	9'-7" (2.92)
15-20 (4.57-6.10)	8'-5" (2.57)	10'-3" (3.12)
20-25 (6.10-7.62)	8'-8" (2.64)	10'-10" (3.30)
25-30 (7.62-9.14)	8'-10" (2.69)	11'-6" (3.51)
30-35 (9.14-10.67)	9'-1" (2.77)	12'-2" (3.71)
35-40 (10.67-12.19)	9'-4" (2.84)	12'-9" (3.89)
40-45 (12.19-13.72)	10'-3" (3.12)	14'-2" (4.32)
45-50 (13.72-15.24)	11'-3" (3.43)	15'-6" (4.72)
50-55 (15.2-16.76)	12'-2" (3.71)	16'-11" (5.16)
55-60 (16.76-18.29)	13'-2" (4.01)	18'-3" (5.56)
60-65 (18.29-19.81)	14'-2" (4.32)	19'-8" (5.99)
65-70 (19.81-21.34)	15'-1" (4.60)	21'-0" (6.40)
70-75 (21.34-22.86)	16'-1" (4.90)	22'-5" (6.83)
75-80 (22.86-24.38)	17'-0" (5.18)	23'-9" (7.24)
80-85 (24.38-25.91)	18'-0" (5.49)	25'-2" (7.76)
85-90 (25.91-27.43)	19'-0" (5.79)	26'-6" (8.08)
90-95 (27.43-28.96)	19'-11" (6.07)	27'-11" (8.51)
95-100 (28.96-30.48)	20'-11" (6.38)	29'-3" (8.92)
Meters are shown in parenthesis		

**Step 2.** Install the anchorage connectors. Some Sayline horizontal lifeline systems include two tie-off adaptor anchorage connectors.

To ensure the tie-off adaptor does not slide down a vertical or sloped anchorage, the tie-off adaptor must be wrapped twice around the structure as shown in Figure 7. Refer to the tie-off adaptor instructions for complete installation information. The horizontal lifeline may be secured directly to the anchorage when the anchorage incorporates a compatible attachment element that meets the requirements specified in section 2.3.

**Figure 7 - Tie-off Adaptor**

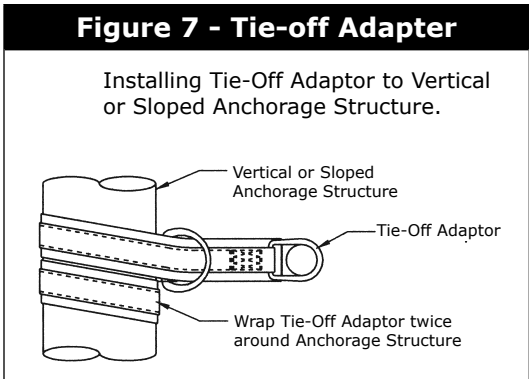

**Step 3.** Secure each end of the horizontal lifeline to the anchorage connectors with the snap hook or carabiner. Loosen and reposition the rope tensioner as required.

**Step 4.** Remove the slack from the horizontal lifeline by pulling the rope through the tensioner by hand. To tension the horizontal lifeline, use a pointed bar or a 1 1/8 in. wrench and turn the tensioning nut clockwise until the tensioner slips. Do not modify the rope tensioner to achieve greater lifeline tension. See Figure 8. The final tension will be 300 to 450 lbs. (1.3 to 2.0 kN).

**Figure 8 - Tensioning the Horizontal Lifeline**

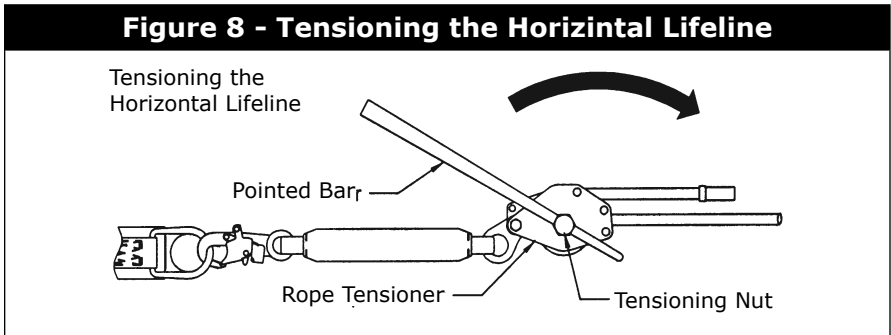

### 3.3 OPERATION:

- A. PERSONAL FALL ARREST SYSTEM COMPONENTS:** Inspect and don the full body harness according to manufacturer's instructions. Attach the connecting subsystem (energy absorbing lanyard or SRL) to the dorsal connection on the harness.
- B. CONNECTING TO THE HORIZONTAL LIFELINE SYSTEM:** Approach the work area using the appropriate access equipment. Connect your personal fall arrest system to one of the attachment O-rings on the horizontal lifeline. Connectors must meet all compatibility and strength requirements.
- C. HAZARDOUS SITUATIONS:** Do not take unnecessary risks, such as jumping or reaching too far from the edge of the working surface. Do not allow the connecting subsystem to pass under arms or between feet. To avoid inadequate clearance, do not climb above the horizontal lifeline. To avoid swing fall hazards, do not work too far from either side of the horizontal lifeline.
- D. TWO (2) PERSONS CONNECTED TO THE HLL:** When a person falls while connected to the horizontal lifeline, the system will deflect. If two (2) persons are connected to the same horizontal lifeline, and one (1) person falls, the second person may be pulled off the working surface due to deflection. The potential for the second person falling increases as the horizontal lifeline span length increases. The use of independent horizontal lifeline systems for each person, or shorter span length, is recommended to minimize the potential of the second person falling.
- E. FREE FALL:** The personal fall arrest system must be rigged to limit free falls to 6 feet (1.8m) or less when using an energy absorbing lanyard, or such that the SRL is overhead without slack, according to OSHA requirements.
- F. SHARP EDGES:** Avoid working where the connecting subsystem or other system components will be in contact with, or abrade against, unprotected sharp edges. If working around sharp edges is unavoidable, a protective cover must be used to prevent cutting of the personal fall arrest system components.
- G. IN THE EVENT OF A FALL:** The responsible party must have a rescue plan and the ability to implement a rescue. Tolerable suspension time in a full body harness is limited, so a prompt rescue is critical.
- H. RESCUE:** With the number of potential scenarios for a worker requiring rescue, an on-site rescue team is beneficial. The rescue team is given the tools, both in equipment and technique, to perform a successful rescue. Training should be provided on a periodic basis to ensure rescuers' proficiency.

## Figure 9 - Releasing Tension from the Horizontal Lifeline

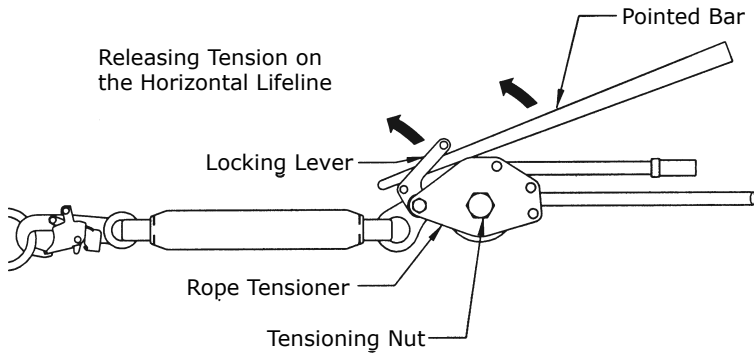

**3.4 SYSTEM REMOVAL:** When no longer required, the horizontal lifeline system should be removed from the job site.

### A. RELEASE TENSION ON THE HORIZONTAL LIFELINE:

- Step 1.** Lift the locking lever and position the pointed bar under the locking lever as shown in Figure 9.
- Step 2.** Push the pointed bar in a upward motion to unlock the lever.
- Step 3.** Loosen the tensioning nut by inserting the pointed bar through the hole in the nut, or use a 1 3/16 in (30 mm) wrench, and turn the tensioning nut counterclockwise.
- Step 4.** Remove all knots and kinks in the rope before storage.

## 4.0 TRAINING

**4.1** It is the responsibility of all users of this equipment to understand these instructions, and to be trained in the correct installation, use, and maintenance of this equipment. These individuals must be aware of the consequences of improper installation or use of this equipment. This user manual is not a substitute for a comprehensive training program. Training must be provided on a periodic basis to ensure proficiency of the users.

## 5.0 INSPECTION

**5.1 INSPECTION FREQUENCY:** The Sayline Synthetic Rope Horizontal Lifeline System shall be inspected by the user before each use and, additionally, by a competent person<sup>1</sup> other than the user after installation and at intervals of no more than one year<sup>2</sup>. Results of the Competent Person inspection should be recorded in the "Inspection and Maintenance Log" at the back of this manual.

**1 Competent Person:** One who is capable of identifying existing and predictable hazards in the surroundings or working conditions which are unsanitary, hazardous, or dangerous to employees, and who has authorization to take prompt corrective measures to eliminate them.

**2 Inspection Frequency:** Extreme working conditions (harsh environments, prolonged use, etc.) may require increasing the frequency of competent person inspections.



## 5.2 INSPECTION STEPS:

- Step 1.** Inspect all metal components (hooks, O-rings, rope tensioner, etc.) for cracks, deformities, corrosion, or other damage that may affect their strength or operation.
- Step 2.** Inspect rope for concentrated wear; especially those portions of the rope that contact the Rope Tensioner. Material must be free of frayed strands, broken yarns, cuts, abrasions, burns, and discoloration. The rope must be free of knots, excessive soiling, paint build-up, and rust staining. Inspect ferrules for cracks or other damage. Thimble must be held firmly by the ferrule. Check for chemical or heat damage; indicated by brown, discolored, or brittle areas. Check for ultraviolet damage; indicated by discoloration, splinters, and slivers along the rope surface. All of the above factors are known to reduce rope strength.

**ROPE CORE:** Concentrated wear, cuts, abrasion, or burns may expose the white inner core of the rope. Any time the white inner core of the rope is visible, excluding the cut ends of the rope, the rope shall be removed from service and no longer used. If the braided black cover must be pulled, spread apart, or separated by hand to expose the white core, the rope is still acceptable for use. Frayed or broken strands that give the rope a "fuzzy" appearance are acceptable, provided the white inner core is not visible.

**Acceptable:**  
White inner core is not exposed.



**Unacceptable:**  
White inner core is exposed.



- Step 3.** Inspect system labels. The labels must be present and fully legible. See section 8.0.

**IMPORTANT:** If this equipment is subjected to the forces of a fall arrest, it must be removed from service and destroyed, or returned to DBI-SALA for inspection or repair.

- 5.3** If inspection reveals an unsafe or defective condition, remove unit from service and destroy, or contact DBI-SALA for possible repair.

**IMPORTANT:** Only DBI-SALA or parties authorized in writing may make repairs to this equipment.

- 5.4 USER EQUIPMENT:** Inspect harness and energy absorbing lanyard or SRL according to manufacturer's instructions.

- 5.5 i-Safe™ RFID TAG:** If your equipment has an i-Safe Radio Frequency Identification (RFID) tag (Figure 10), the RFID tag can be used with a reading device to simplify inspection and provide records for your equipment. Contact Capital Safety or see the Capital Safety website (<http://www.capitalsafety.com/en-us/Pages/i-Safe.aspx>).

**Figure 10 - RFID**

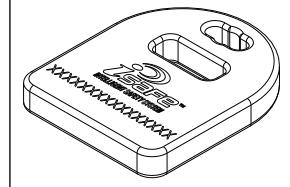

## **6.0 MAINTENANCE, SERVICING, STORAGE**

- 6.1 CLEANING AND MAINTENANCE:** Clean the horizontal lifeline system with water and a mild detergent. Wipe dry with a clean, dry cloth and hang to air dry. Do not force dry with heat. An excessive build-up of dirt, paint, etc. may prevent the system from working properly, and in severe cases, weaken the rope. A lubricant may be applied to the moving parts of the rope tensioner. Do not allow lubricant to contact the rope tensioner teeth.
- 6.2 STORAGE:** Store this horizontal lifeline system in a clean, dry environment, out of direct sunlight. Avoid areas where chemical vapors are present. Thoroughly inspect the system after extended storage.
- 6.3 USER EQUIPMENT:** Maintain, service, and store user equipment according to manufacturer's instructions.

## **7.0 SPECIFICATIONS**

### **7.1 MATERIALS:**

- **Rope Tensioner:** Steel, plated
- **O-rings:** Alloy steel, plated
- **Lifeline Rope:** 11/16 in. nylon, static kernmantle, breaking strength: 12,000 lb.
- **Rope Tensioner Strap:** Polyester/Nylon
- **Snap Hooks:** Alloy steel, plated
- **Carabiners:** High tensile alloy steel, plated
- **Tie-off Adaptor:** Polyester web, plated alloy steel hardware

## 8.0 LABELING

### 8.1 The following labels must be present and fully legible:

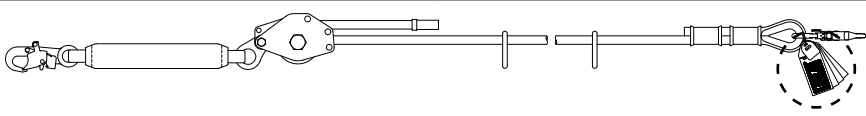

**WARNING** MANUFACTURER'S INSTRUCTIONS MUST BE READ AND UNDERSTOOD PRIOR TO USE. INSTRUCTIONS SUPPLIED WITH THIS PRODUCT AT TIME OF SHIPMENT MUST BE FOLLOWED FOR PROPER USE, MAINTENANCE, AND INSPECTION. ENSURE HORIZONTAL LIFELINE IS LOCATED AT AN ELEVATION WHICH WILL LIMIT FREE FALLS TO A MAXIMUM OF 6 FEET WHEN USING SHOCK ABSORBING LANYARDS, AND LOCATED OVERHEAD WHEN USING SELF RETRACTING LIFELINES. SHOCK ABSORBING LANYARDS AND SELF RETRACTING LIFELINES USED TO CONNECT TO THIS SYSTEM MUST LIMIT MAXIMUM ARRESTING FORCES TO 300 LBS. THIS EQUIPMENT MUST BE INSTALLED AND USED UNDER THE SUPERVISION OF A QUALIFIED PERSON. MAKE ONLY COMPATIBLE CONNECTIONS. EXERCISE CAUTION USING THIS EQUIPMENT NEAR HAZARDOUS THERMAL, ELECTRICAL, OR CHEMICAL SOURCES. ALTERATION OR MISUSE OF THIS PRODUCT, OR FAILURE TO FOLLOW INSTRUCTIONS MAY RESULT IN SERIOUS INJURY OR DEATH. REMOVE FROM SERVICE IF SUBJECT TO FALL ARREST FORCES. DO NOT REMOVE THIS LABEL.

**DBI**  
**SALA**®  
www.ccpilife.com

**WARNING** THIS CLEARANCE CHART ONLY APPLIES TO HORIZONTAL LIFELINE (HLL) SYSTEMS RIGGED AT OR ABOVE SHOULDER HEIGHT, WITH WORKERS CONNECTED TO THE HLL USING 6 FT LONG ENERGY ABSORBING LANYARDS. SEE USER MANUAL FOR FURTHER DETAILS.

**CLEARANCE CHART**

SPAN LENGTH (FT)	VERTICAL CLEARANCE (FT) REQUIRED FROM UPPER LEVEL OF OBSTRUCTION
10	22
20	26
30	30
40	34
50	38
60	42

THE PEOPLE CONNECTED TO HORIZONTAL LIFELINE  
BE FROM CONNECTED TO HORIZONTAL LIFELINE

**INSPECTION:** BEFORE EACH USE INSPECT SYSTEM TO DETERMINE IF IT IS IN GOOD CONDITION WITH ALL CONNECTIONS PROPERLY SECURED. AT LEAST MONTHLY, SYSTEM SHOULD BE INSPECTED BY A COMPETENT PERSON IN ACCORDANCE WITH THE USER MANUAL. DO NOT USE IF INSPECTION REVEALS AN UNSAFE OR DEFECTIVE CONDITION. NOT USER REPAIRABLE.

**SYNTHETIC HORIZONTAL LIFELINE SYSTEM**

MFRD (YR/MO) / LOT:      MODEL NO:      LENGTH (FT):

**SPECIFICATIONS:** THIS HORIZONTAL LIFELINE SYSTEM HAS A MAXIMUM CAPACITY OF TWO WORKERS, MAXIMUM WORKER WEIGHT, INCLUDING TOOLS AND CLOTHING, IS 310 LBS. THE SYSTEM COMPONENT MATERIALS ARE AS FOLLOWS: ROPE TIGHTENER - STEEL; HLL ROPE - NYLON; CONNECTING WEB STRAP - POLYESTER; SNAP HOOKS AND OTHER HARDWARE - STEEL. THIS SYSTEM MEETS OSHA REQUIREMENTS FOR FALL PROTECTION SYSTEMS WHEN USED IN ACCORDANCE WITH THE USER MANUAL.

This product is **i-Force enabled**, and contains an electronic tag that can be used for connective routes - inventory inspection logs, inventory management and other safety information.

De produit est activé dans i-Force et contient une étiquette électronique qui peut être utilisée pour des vérifications d'inventaire, des logs de vérification des stocks et d'autres informations relatives à la protection.

www.ccpilife.com



INSPECTION LOG

INSPECTOR	DATE







This instruction applies to the following models:

5908549	7600503	7600508	7600513	7600518
7600008	7600504	7600509	7600514	7600519
7600009	7600505	7600510	7600515	7600520
7600501	7600506	7600511	7600516	7600521
7600502	7600507	7600512	7600517	7611904

*Additional model numbers may appear on the next printing of these instructions*

## LIMITED LIFETIME WARRANTY

**Warranty to End User:** D B Industries, Inc., dba CAPITAL SAFETY USA ("CAPITAL SAFETY") warrants to the original end user ("End User") that its products are free from defects in materials and workmanship under normal use and service. This warranty extends for the lifetime of the product from the date the product is purchased by the End User, in new and unused condition, from a CAPITAL SAFETY authorized distributor. CAPITAL SAFETY'S entire liability to End User and End User's exclusive remedy under this warranty is limited to the repair or replacement in kind of any defective product within its lifetime (as CAPITAL SAFETY in its sole discretion determines and deems appropriate). No oral or written information or advice given by CAPITAL SAFETY, its distributors, directors, officers, agents or employees shall create any different or additional warranties or in any way increase the scope of this warranty. CAPITAL SAFETY will not accept liability for defects that are the result of product abuse, misuse, alteration or modification, or for defects that are due to a failure to install, maintain, or use the product in accordance with the manufacturer's instructions.

CAPITAL SAFETY'S WARRANTY APPLIES ONLY TO THE END USER. THIS WARRANTY IS THE ONLY WARRANTY APPLICABLE TO OUR PRODUCTS AND IS IN LIEU OF ALL OTHER WARRANTIES AND LIABILITIES, EXPRESSED OR IMPLIED. CAPITAL SAFETY EXPRESSLY EXCLUDES AND DISCLAIMS ANY IMPLIED WARRANTIES OF MERCHANTABILITY OR FITNESS FOR A PARTICULAR PURPOSE, AND SHALL NOT BE LIABLE FOR INCIDENTAL, PUNITIVE OR CONSEQUENTIAL DAMAGES OF ANY NATURE, INCLUDING WITHOUT LIMITATION, LOST PROFITS, REVENUES, OR PRODUCTIVITY, OR FOR BODILY INJURY OR DEATH OR LOSS OR DAMAGE TO PROPERTY, UNDER ANY THEORY OF LIABILITY, INCLUDING WITHOUT LIMITATION, CONTRACT, WARRANTY, STRICT LIABILITY, TORT (INCLUDING NEGLIGENCE) OR OTHER LEGAL OR EQUITABLE THEORY.



The Ultimate in Fall Protection

### **CSG USA & Latin America**

3833 SALA Way  
Red Wing, MN 55066-5005  
Toll Free: 800.328.6146  
Phone: 651.388.8282  
Fax: 651.388.5065  
solutions@capitalsafety.com

### **CSG Canada**

260 Export Boulevard  
Mississauga, ON L5S 1Y9  
Phone: 905.795.9333  
Toll-Free: 800.387.7484  
Fax: 888.387.7484  
info.ca@capitalsafety.com

### **CSG Northern Europe**

5a Merse Road  
North Moons, Moat  
Reditch, Worcestershire, UK  
B98 9HL  
Phone: + 44 (0)1527 548 000  
Fax: + 44 (0)1527 591 000  
csgne@capitalsafety.com

### **CSG EMEA**

#### **(Europe, Middle East, Africa)**

Le Broc Center  
Z.I. 1ère Avenue  
5600 M B.P. 15 06511  
Carros  
Le Broc Cedex  
France  
Phone: + 33 4 97 10 00 10  
Fax: + 33 4 93 08 79 70  
information@capitalsafety.com

### **CSG Australia & New Zealand**

95 Derby Street  
Silverwater  
Sydney NSW 2128  
AUSTRALIA  
Phone: +(61) 2 8753 7600  
Toll-Free : 1 800 245 002 (AUS)  
Toll-Free : 0800 212 505 (NZ)  
Fax: +(61) 2 87853 7603  
sales@capitalsafety.com.au

### **CSG Asia**

*Singapore:*  
Rm 1406, Enterprise Road  
Singapore 627666  
Phone: +65 - 65587758  
Fax: +65 - 65587058  
inquiry@capitalsafety.com

*Shanghai:*  
Rm 1406, China Venturetech Plaza  
819 Nan Jing Xi Rd,  
Shanghai 200041, P R China  
Phone: +86 21 62539050  
Fax: +86 21 62539060

[www.capitalsafety.com](http://www.capitalsafety.com)

