



Instructions for the following series products:

Zorbit Energy Absorber Kits

(See back page for specific model numbers.)

User Instruction Manual
Zorbit™ Energy Absorber Kits for Horizontal Lifeline Systems

This manual is provided as the Manufacturer's Instructions, and should be used as part of an employee training program as required by OSHA.

WARNING: This product is part of a fall protection system. The users must read and follow the manufacturer's instructions for each component of the system. These instructions must be provided to the users of this equipment. The users must read and understand these instructions before using this equipment. Manufacturer's instructions must be followed for proper use and maintenance of this product. Alterations or misuse of this product, or failure to follow instructions, may result in serious injury or death.

Figure 1 - Parts Identification

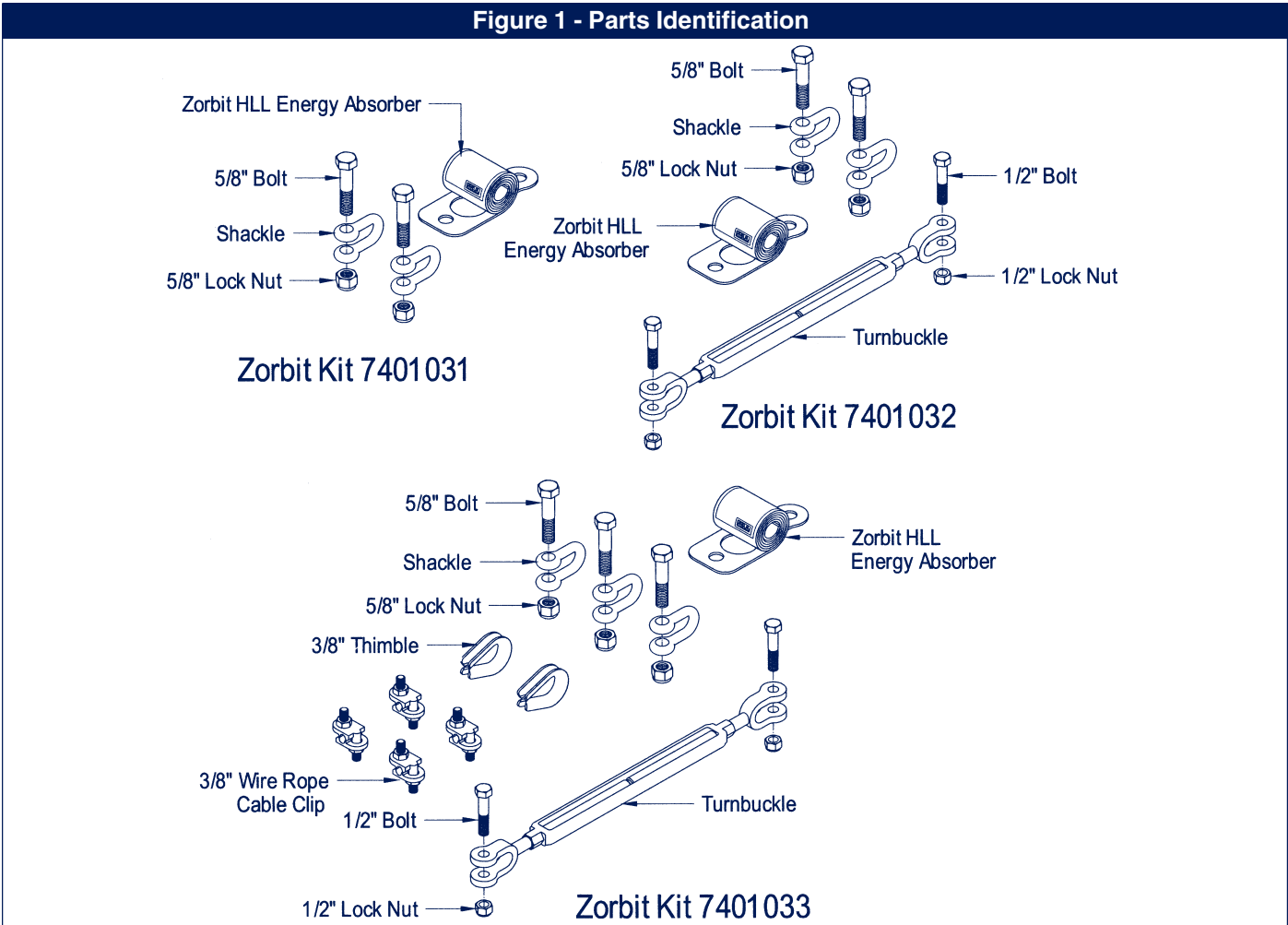

IMPORTANT: If you have questions on the use, care, or suitability of this equipment for your application, contact DBI/SALA.

1.0 APPLICATION

1.1 PURPOSE: Zorbit Horizontal Lifeline (HLL) energy absorber kits are intended to be used as elements within a horizontal lifeline subsystem (HLLSS), forming part of a complete personal fall arrest system (PFAS). See Figure 1 for Zorbit kit numbers and parts identification. See Figure 2 for a description of a personal fall arrest system incorporating a horizontal lifeline subsystem.

1.2 LIMITATIONS: The following limits apply to the installation and use of Zorbit HLL energy absorber kits. Other limitations may apply:

IMPORTANT: OSHA regulations state that horizontal lifelines shall be designed, installed, and used under the supervision of a qualified person (see below for definition) as part of a complete personal fall arrest system that maintains a safety factor of at least two.

Qualified Person: An individual with a recognized degree or professional certificate, and an extensive knowledge and experience in the subject field, who is capable of design, analysis, evaluation, and specification in the subject work, project, or product. Refer to OSHA 1910.66, 1926.32, and 1926.502.

Figure 2 - Personal Fall Arrest System (PFAS) Incorporating a Horizontal Lifeline System

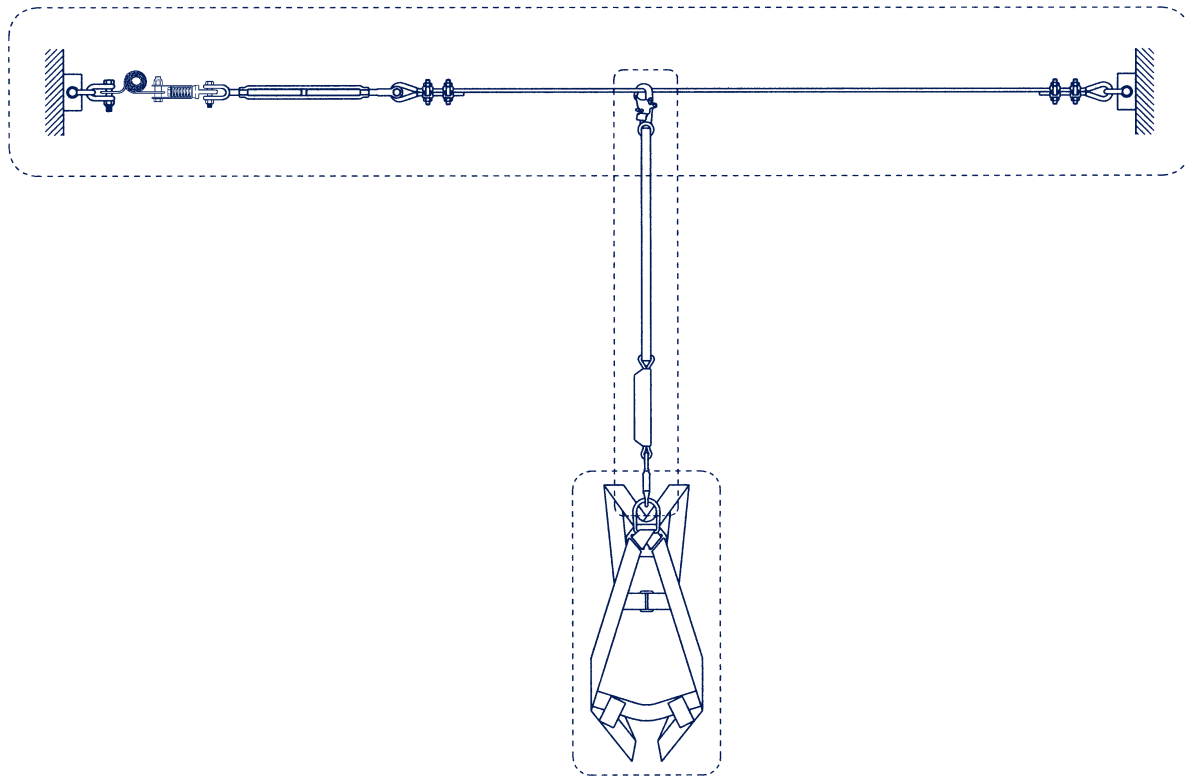

- A. HORIZONTAL LIFELINE SPAN:** Zorbit HLL energy absorbers must only be used for single span horizontal lifeline applications. Multiple span systems using intermediate supports are not allowed. The maximum horizontal lifeline span length is 60 feet when using a single Zorbit HLL energy absorber, or 100 feet when a Zorbit HLL energy absorber is installed on each end of the system. See Figure 3. The span length must be reduced when clearance is limited. See section 3.0 for clearance information.
- B. SYSTEM CAPACITY:** The maximum capacity of horizontal lifeline subsystems (see Figure 2) with Zorbit HLL energy absorbers is two persons. The maximum weight of each person, including tools and clothing, is 310 lbs.
- C. CONNECTING SUBSYSTEM:** Each person's connecting subsystem (see Figure 2) must limit fall arrest forces to 900 lbs. or less. See section 2.6.
- D. FREE FALL:** Rig and use the personal fall arrest system such that the maximum potential free fall does not exceed government regulatory and subsystem manufacturer's requirements. See section 3.0 and subsystem manufacturer's instructions for more information.
- E. SWING FALLS:** Swing falls occur when the anchorage point is not directly overhead. The force of striking an object in a swing fall may cause serious injury or death. Minimize swing falls by working as directly below the anchorage point as possible. Do not permit a swing fall if injury could occur. See Figure 4. Swing falls will significantly increase the clearance required when a self retracting lifeline or other variable length connecting subsystem is used. If a swing fall situation exists in your application, contact DBI/SALA before proceeding.

Figure 3 - Typical Horizontal Lifeline Installation with Zorbit Kits

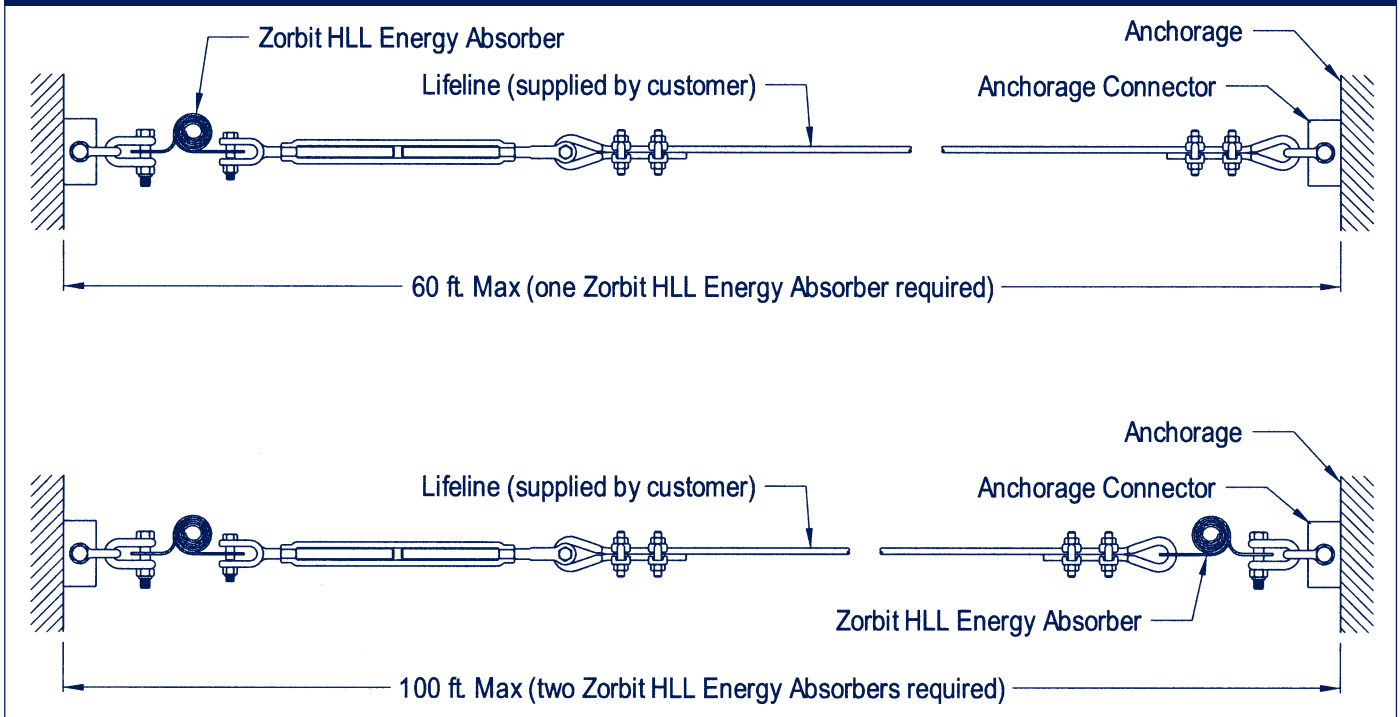

CAUTION: Do not rigidly mount Zorbit to structure or stanchion. May cause failure due to bending. Mount so Zorbit can pivot and move freely as shown in Figure 3.

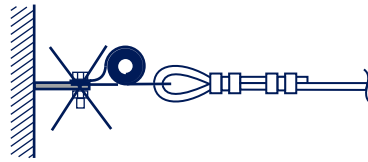

- F. FALL CLEARANCE:** There must be sufficient clearance below the worker to arrest a fall before striking the lower level or obstruction. See section 3.0 for required clearance information.
- G. BODY SUPPORT:** Zorbit HLL energy absorbers must only be used with personal fall arrest systems incorporating a full body harness. See Figure 2.
- H. PHYSICAL AND ENVIRONMENTAL HAZARDS:** Use of this equipment in areas with physical or environmental hazards may require additional precautions to reduce the possibility of injury to the user or damage to the equipment. Hazards may include, but are not limited to; heat, chemicals, corrosive environments, high voltage power lines, gases, moving machinery, and sharp edges. Contact DBI/SALA if you have questions about using this equipment where physical or environmental hazards exist.
- I. TRAINING:** This equipment must be installed and used by persons trained in the correct application and use of this equipment. See section 4.0.

1.3 APPLICABLE STANDARDS: Refer to national standards, including ANSI Z359.1 and local, state, and federal (OSHA 1910.66 and 1926.502) requirements for more information on personal fall arrest systems and associated components.

2.0 SYSTEM REQUIREMENTS

2.1 COMPATIBILITY OF COMPONENTS AND SUBSYSTEMS: Zorbit HLL energy absorbers and Zorbit kit components must only be used with fall arrest system components, subsystems, or elements that have been

Figure 4 - Swing Fall Hazard

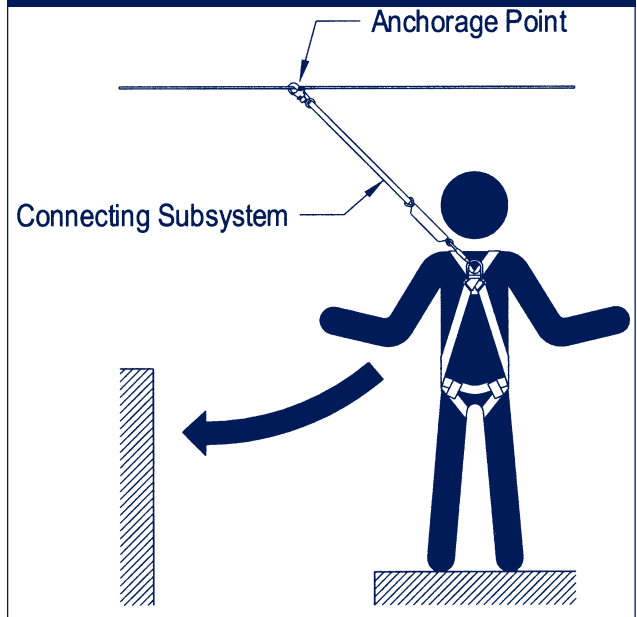

designated by the manufacturer as suitable for such use, and comply with these instructions. Non-compatible components and subsystems could affect the safety and reliability of the complete system.

2.2 COMPATIBILITY OF CONNECTORS: Connectors are considered to be compatible with connecting elements when they have been designed to work together in such a way that their sizes and shapes do not cause their gate mechanisms to inadvertently open regardless of how they become oriented. Contact DBI/SALA if you have any questions about compatibility.

Figure 5 - Unintentional Disengagement (Roll-out)

If the connecting element that a snap hook (shown) or carabiner attaches to is undersized or irregular in shape, a situation could occur where the connecting element applies a force to the gate of the snap hook or carabiner. This force may cause the gate (of either a self-locking or a non-locking snap hook) to open, allowing the snap hook or carabiner to disengage from the connecting point.

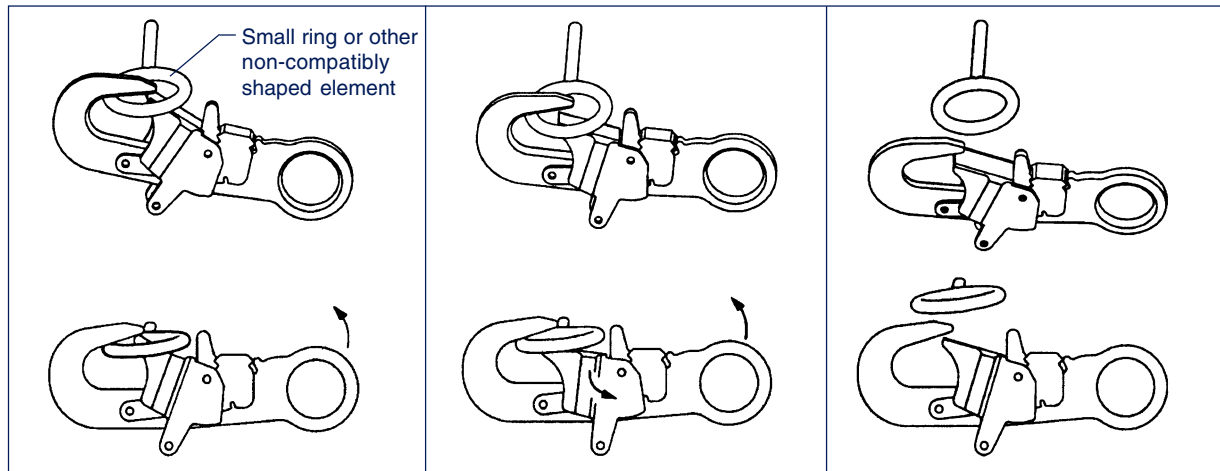

1. Force is applied to the snap hook.

2. The gate presses against the connecting ring.

3. The gate opens allowing the snap hook to slip off.

Connectors (hooks, carabiners, and D-rings) must be capable of supporting at least 5,000 lbs. (22.2kN). Connectors must be compatible with the anchorage or other system components. Do not use equipment that is not compatible. Non-compatible connectors may unintentionally disengage. See Figure 5. Connectors must be compatible in size, shape, and strength. Self locking snap hooks and carabiners are required by ANSI Z359.1 and OSHA.

2.3 MAKING CONNECTIONS: Only use self-locking snap hooks and carabiners with this equipment. Only use connectors that are suitable to each application. Ensure all connections are compatible in size, shape and strength. Do not use equipment that is not compatible. Ensure all connectors are fully closed and locked.

DBI/SALA connectors (snap hooks and carabiners) are designed to be used only as specified in each product's user's instructions. See Figure 6 for inappropriate connections. DBI/SALA snap hooks and carabiners should not be connected:

- A. To a D-ring to which another connector is attached.
- B. In a manner that would result in a load on the gate.

NOTE: Large throat opening snap hooks should not be connected to standard size D-rings or similar objects which will result in a load on the gate if the hook or D-ring twists or rotates. Large throat snap hooks are designed for use on fixed structural elements such as rebar or cross members that are not shaped in a way that can capture the gate of the hook.

- C. In a false engagement, where features that protrude from the snap hook or carabiner catch on the anchor and without visual confirmation seems to be fully engaged to the anchor point.
- D. To each other.
- E. Directly to webbing or rope lanyard or tie-back (unless the manufacturer's instructions for both the lanyard and connector specifically allow such a connection).

- F. To any object which is shaped or dimensioned such that the snap hook or carabiner will not close and lock, or that roll-out could occur.

2.4 STRUCTURE LOAD REQUIREMENTS: Structural anchorage points must be rigid and capable of supporting at least 5,000 lbs. along the axis of the horizontal lifeline. Anchorages must also support at least 3,600 lbs. applied in all potential directions of fall arrest that are perpendicular to the axis of the horizontal lifeline. See Figure 7.

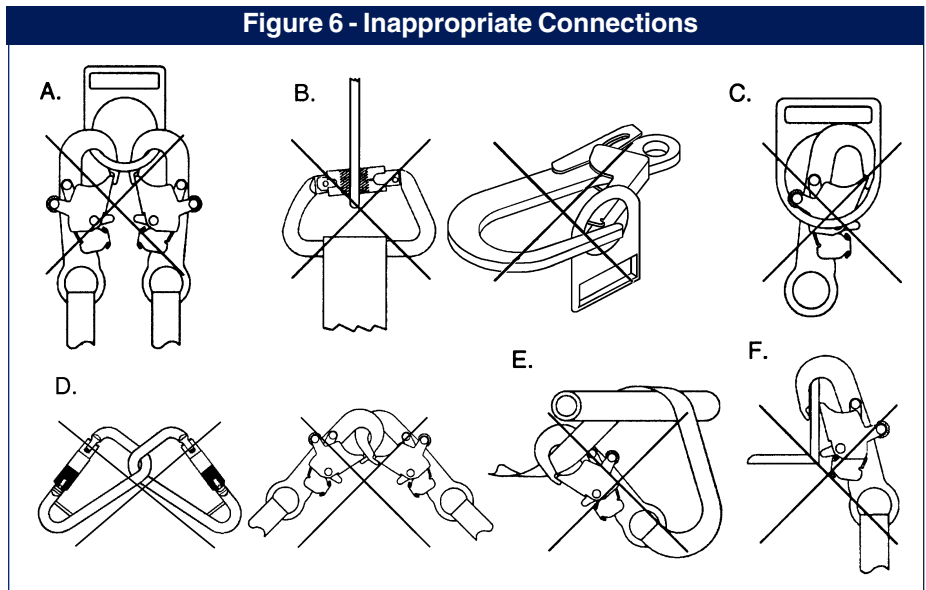

WARNING: Anchorages must be rigid. Large deformations of the anchorage will affect system performance, and may increase the required fall clearance below the system, which could result in serious injury or death.

2.5 LIFELINE WIRE ROPE REQUIREMENTS: DBI/SALA requires as a minimum, 3/8-inch diameter, 7x19 galvanized aircraft cable. The system performance information contained in this manual is based on using this wire rope type. Larger cable sizes with greater or equal strength and stiffness properties may also be used. Do not use synthetic lifelines. NOTE: Wire rope cable clips provided with Zorbit kit 7401033 are for use with 3/8-inch diameter wire rope only.

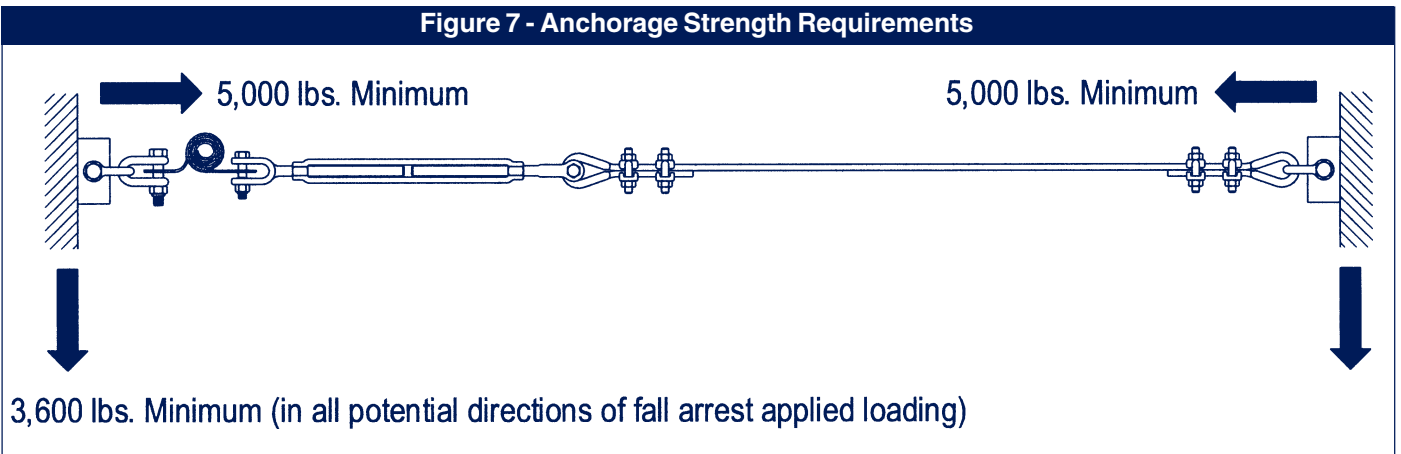

2.6 CONNECTING SUBSYSTEM REQUIREMENTS: The connecting subsystem is the portion of the personal fall arrest system that is used to connect between the horizontal lifeline subsystem and harness fall arrest attachment element (see Figure 2). For systems incorporating Zorbit HLL energy absorbers, each connecting subsystem must limit forces applied to the horizontal lifeline to 900 lbs. or less.

3.0 OPERATION AND USE

WARNING: Do not alter or intentionally misuse this equipment. Use caution when using this equipment around moving machinery, electrical and chemical hazards, and sharp edges.

WARNING: Consult your doctor if there is reason to doubt your fitness to absorb the impact from a fall arrest. Age and fitness can affect your ability to withstand fall arrest forces. Pregnant women and minors must not use this system.

3.1 BEFORE EACH USE inspect this equipment according to steps listed in section 5.2. Do not use this equipment if inspection reveals an unsafe or defective condition. Plan your use of the fall protection system prior to exposing workers to dangerous situations. Consider all factors affecting your safety before using this system.

Figure 8 - Clearance Evaluation using DBI/SALA Energy Absorbing Lanyards

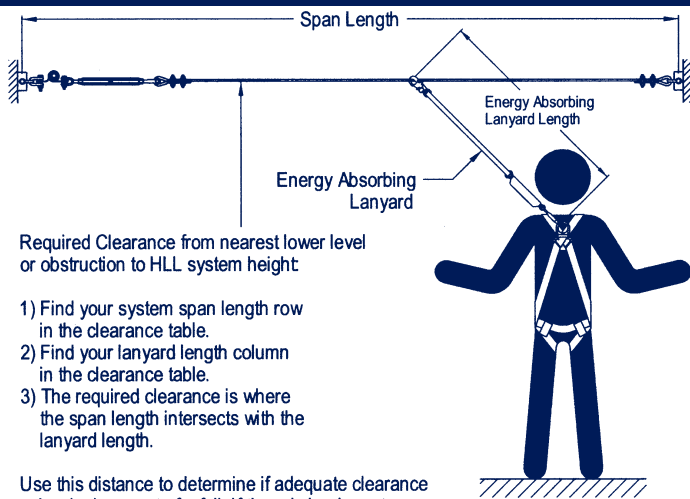

Required Clearance from nearest lower level or obstruction to HLL system height:

- 1) Find your system span length row in the clearance table.
- 2) Find your lanyard length column in the clearance table.
- 3) The required clearance is where the span length intersects with the lanyard length.

Use this distance to determine if adequate clearance exists in the event of a fall. If there is inadequate clearance, do not use the system, or reduce your span or lanyard length and reevaluate your required clearance.

Example: Span is 42 feet, lanyard length is 5 feet, your required clearance is 21' - 6"

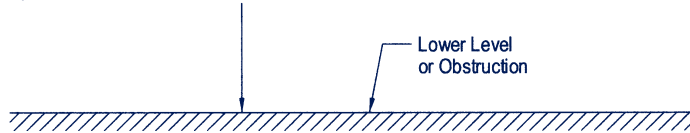

Clearance Table - DBI/SALA Energy Absorbing Lanyards
(Clearances given in feet and inches)

Span Length (in feet)	Length of Energy Absorbing Lanyard (in feet and inches)			
	3	4	5	6
>0 but ≤10	14' - 11"	15' - 11"	16' - 11"	17' - 11"
10 - 15	15' - 7"	16' - 7"	17' - 7"	18' - 7"
15 - 20	16' - 2"	17' - 2"	18' - 2"	19' - 2"
20 - 25	16' - 11"	17' - 11"	18' - 11"	19' - 11"
25 - 30	17' - 6"	18' - 6"	19' - 6"	20' - 6"
30 - 35	18' - 2"	19' - 2"	20' - 2"	21' - 2"
35 - 40	18' - 10"	19' - 10"	20' - 10"	21' - 10"
40 - 45	19' - 6"	20' - 6"	21' - 6"	22' - 6"
45 - 50	20' - 1"	21' - 1"	22' - 1"	23' - 1"
50 - 55	20' - 10"	21' - 10"	22' - 10"	23' - 10"
55 - 60	21' - 5"	22' - 5"	23' - 5"	24' - 5"
60 - 65	22' - 1"	23' - 1"	24' - 1"	25' - 1"
65 - 70	22' - 8"	23' - 8"	24' - 8"	25' - 8"
70 - 75	23' - 5"	24' - 5"	25' - 5"	26' - 5"
75 - 80	24' - 0"	25' - 0"	26' - 0"	27' - 0"
80 - 85	24' - 8"	25' - 8"	26' - 8"	27' - 8"
85 - 90	25' - 4"	26' - 4"	27' - 4"	28' - 4"
90 - 95	26' - 0"	27' - 0"	28' - 0"	29' - 0"
95 - 100	26' - 7"	27' - 7"	28' - 7"	29' - 7"

> Greater than
≤ Less than or equal to

Figure 9 - Clearance Evaluation using DBI/SALA Self Retracting Lifelines

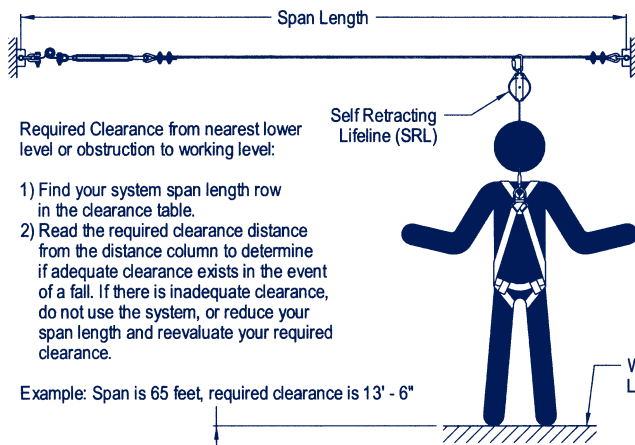

Required Clearance from nearest lower level or obstruction to working level:

- 1) Find your system span length row in the clearance table.
- 2) Read the required clearance distance from the distance column to determine if adequate clearance exists in the event of a fall. If there is inadequate clearance, do not use the system, or reduce your span length and reevaluate your required clearance.

Example: Span is 65 feet, required clearance is 13' - 6"

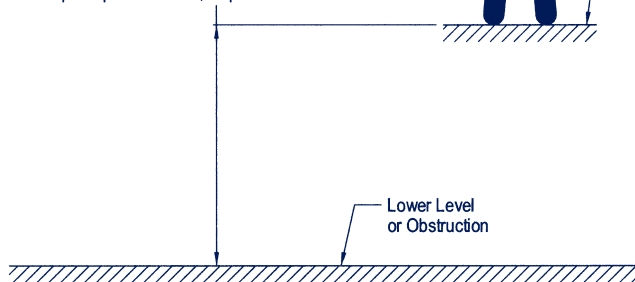

WARNING: This information only applies when the HLL and SRL are located overhead and above the level of the harness attachment point, and the user is standing.

Clearance Table - DBI/SALA Self Retracting Lifelines
(Clearances given in feet and inches)

Span Length (in feet)	Required Distance
>0 but ≤10	6' - 11"
10 - 20	8' - 0"
20 - 30	9' - 1"
30 - 40	10' - 2"
40 - 50	11' - 4"
50 - 60	12' - 5"
60 - 70	13' - 6"
70 - 80	14' - 7"
80 - 90	15' - 8"
90 - 100	16' - 10"

> Greater than
≤ Less than or equal to

- Read and understand all manufacturer's instructions for each component of the personal fall arrest system. All DBI/SALA harnesses and connecting subsystems are supplied with separate user instructions. Keep all instructions for future reference.
- Review sections 1.0 and 2.0 to ensure system limitations and other requirements have been adhered to. Review applicable information regarding system clearance criteria, and ensure changes have not been made to the system installation (i.e. length), or occurred at the job site, that could affect the required fall clearance.
- Do not use the system if changes are required.

3.2 HORIZONTAL LIFELINE INSTALLATION WHEN USING DBI/SALA CONNECTING SUBSYSTEMS:

Figure 3 shows typical horizontal lifeline system installations. When using an energy absorbing lanyard to connect to the system, the end anchorages must be located at a height which will limit the free fall to 6 feet. When using a self retracting lifeline (SRL) to connect to the system, the end anchorages must be located above the worker. The SRL, when fully retracted, must be above the harness attachment level. The HLL system should be positioned at a level that will minimize free fall, but allow ease of use. The lifeline should be positioned near the work location to minimize swing fall hazards (see Figure 4). The connecting subsystem length should be kept as short as possible to reduce the potential free fall and required clearance distance. Both anchorages must be installed at approximately the same elevation, so that the HLL system is not sloped more than 5 degrees.

IMPORTANT: Lifeline installation must be supervised by a qualified person. See section 1.2.

- Step 1.** Determine the locations of the end anchorages and evaluate their strengths in accordance with section 2.4. Determine the span length and evaluate the required clearance using Figure 8 or 9. Figures 8 and 9 apply to one or two users connected to the system.
- Step 2.** If possible, assemble the HLL system on the ground before attaching to the anchorages using hardware provided, or with customer supplied connecting components. Connectors must meet the requirements specified in section 2.2. Typical lifeline assemblies are shown in Figure 3. See section 2.5 for wire rope specifications. Ensure all fasteners are properly tightened. Leave slack in the turnbuckle to allow for system tensioning.

IMPORTANT: Lifeline assemblies longer than 60 feet require a Zorbit HLL energy absorber on each lifeline end.

- Step 3.** Install the lifeline assembly to structural anchorage attachment points. See section 2.4 for anchorage specifications. Tension the lifeline until taut. The cable deflection at mid-span must be 6 inches or less, with no weight on the HLL. See Figure 10 for installation of 3/8-inch thimble and cable clips supplied with Zorbit kit 7401033.

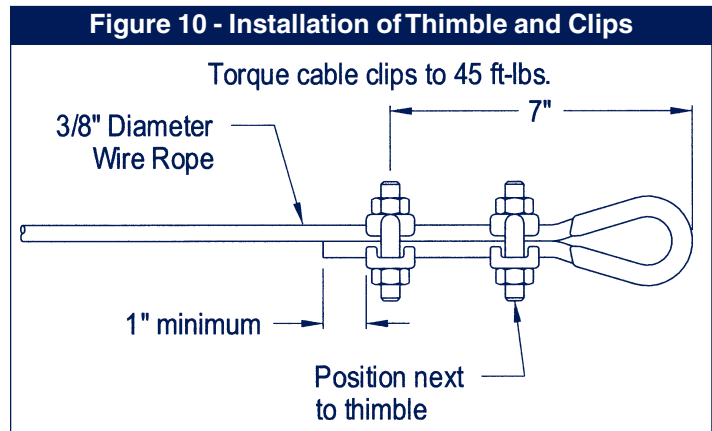

3.3 HORIZONTAL LIFELINE INSTALLATION WHEN USING OTHER THAN DBI/SALA CONNECTING SUBSYSTEMS:

The lifeline may be installed as described in section 3.2 above, however, because DBI/SALA cannot predict the performance of non-DBI/SALA subsystem components, Figures 8 and 9 do not apply. The required clearance must be determined by using the lifeline deflection data given in Figure 11, and subsystem performance provided by the manufacturer. Figures 12 and 13 show clearance factors to consider.

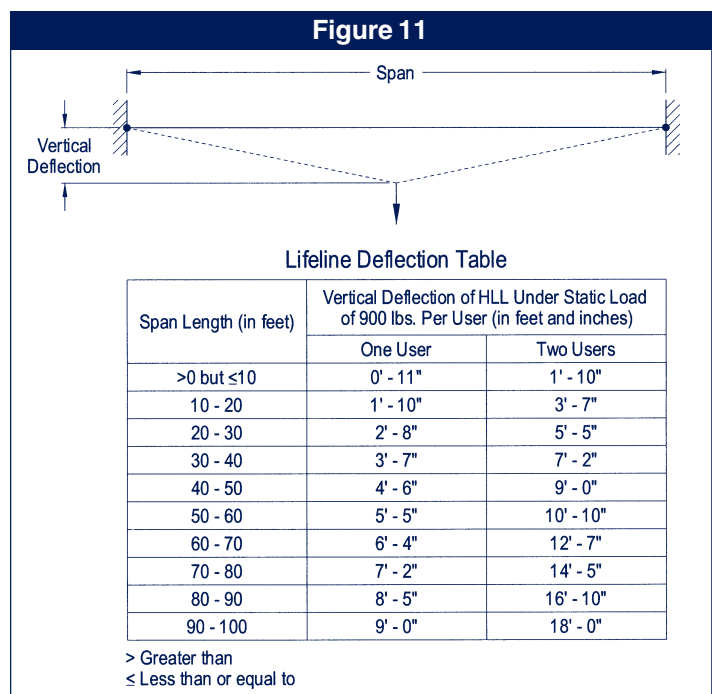

3.4 OPERATION:

A. PERSONAL FALL ARREST SYSTEM COMPONENTS:

Inspect and don the full body harness according to manufacturer's instructions. Attach the connecting subsystem (energy absorbing lanyard or SRL) to the dorsal connection on the harness.

Figure 12 - Clearance Evaluation Factors- Energy Absorbing Lanyards

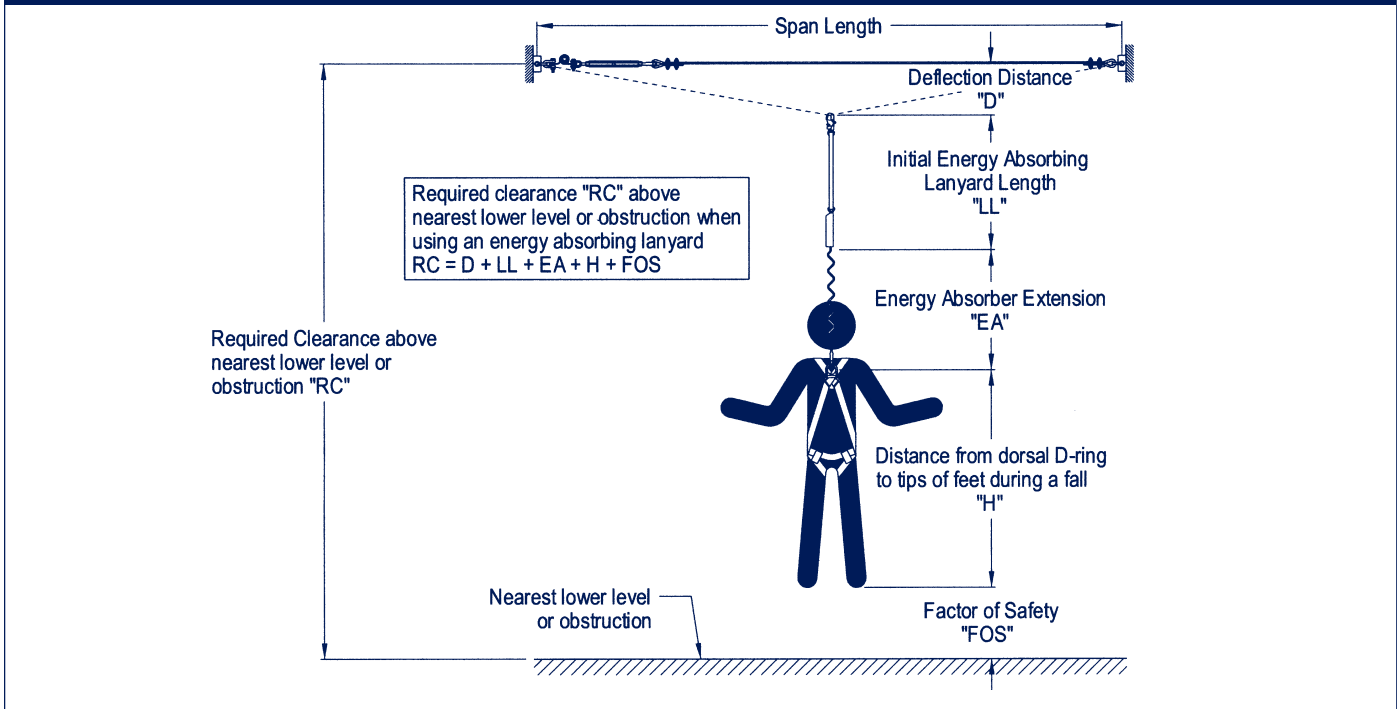
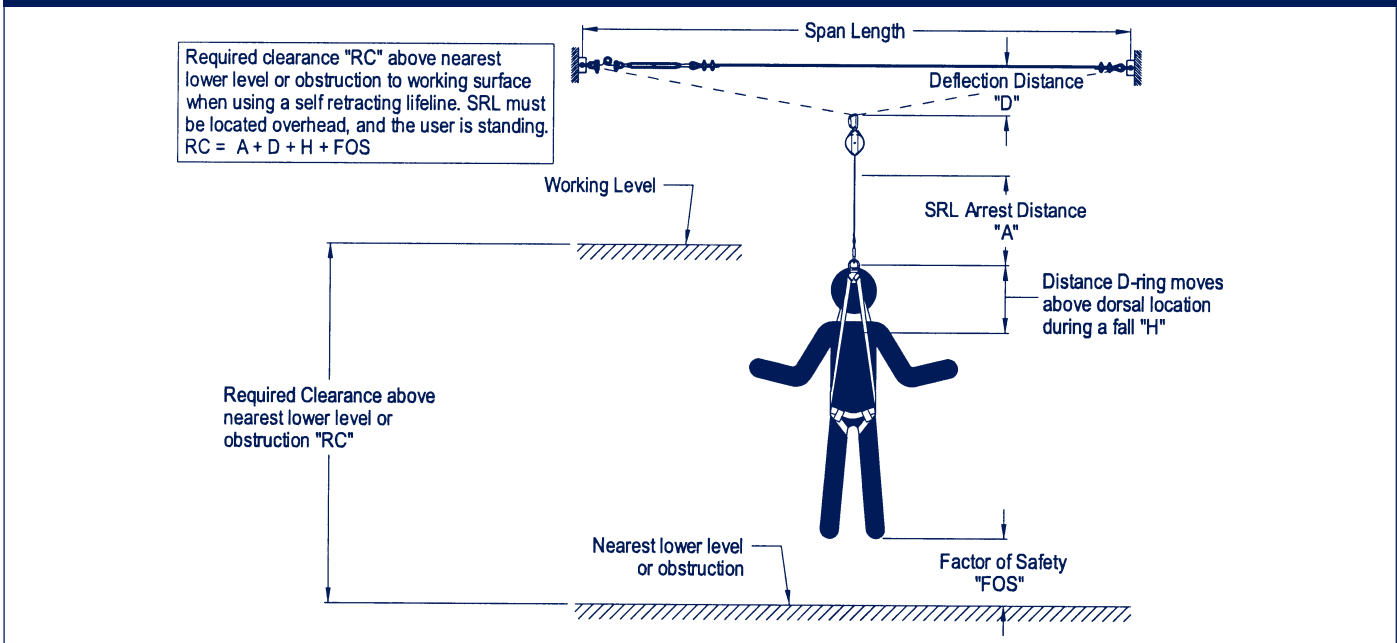

Figure 13 - Clearance Evaluation Factors - Self Retracting Lifelines



- B. CONNECTING TO THE HLL SYSTEM:** Approach the work area using the appropriate access equipment. Secure the personal fall arrest system by attaching the energy absorbing lanyard or SRL to the HLL. Connectors must meet all compatibility and strength requirements. NOTE: Due to their weight, SRLs may require a rolling connection (pulley) to the lifeline.
- C. HAZARDOUS SITUATIONS:** Do not take unnecessary risks, such as jumping or reaching too far from the edge of the working surface. Do not allow the connecting subsystem to pass under arms or between feet. To avoid inadequate clearance, do not climb above the HLL. To avoid swing fall hazards, do not work too far from either side of the HLL.
- D. TWO PERSONS CONNECTED TO THE HLL:** When a person falls while connected to the HLL, the system will deflect. If two persons are connected to the same HLL, and one person falls, the second person may be pulled off the working surface due to deflection. The potential for the second person falling increases as the HLL span length increases. The use of independent HLL systems for each person, or shorter span length, is recommended to minimize the potential of the second person falling.

- E. FREE FALL:** The personal fall arrest system must be rigged to limit free falls to 6 feet or less when using an energy absorbing lanyard, or such that the SRL is overhead and without slack, according to OSHA requirements.
- F. SHARP EDGES:** Avoid working where the connecting subsystem or other system components will be in contact with, or abrade against, unprotected sharp edges. If working around sharp edges is unavoidable, a protective cover must be used to prevent cutting of the PFAS components.
- G. IN THE EVENT OF A FALL:** The responsible party must have a rescue plan and the ability to implement a rescue. Tolerable suspension time in a full body harness is limited, so a quick rescue is critical.

IMPORTANT: Use care when handling an expended Zorbit energy absorber. The tearing of the energy absorber material produces extremely sharp edges.

- H. RESCUE:** With the number of potential scenarios for a worker requiring rescue, an on site rescue team is beneficial. The rescue team is given the tools, both in equipment and techniques, so it can perform a successful rescue. Training should be provided on a periodic basis to ensure rescuers proficiency.

3.5 SYSTEM REMOVAL: When no longer required, the HLL system should be removed from the job site. To slacken the HLL, loosen the turnbuckle until tension is removed from the wire rope. Disconnect the HLL system from the anchorages. Ensure there are no knots or kinks in the wire rope before storage.

4.0 TRAINING

4.1 It is the responsibility of all users of this equipment to understand these instructions, and are trained in the correct installation, use, and maintenance of this equipment. These individuals must be aware of the consequences of improper installation or use of this equipment. This user manual is not a substitute for a comprehensive training program. Training must be provided on a periodic basis to ensure proficiency of the users.

5.0 INSPECTION

5.1 FREQUENCY

BEFORE EACH INSTALLATION: Inspect the Zorbit HLL energy absorber, kit components, and other system components according to these or other manufacturer's instructions. System components must be formally inspected by a qualified person (other than the user). Formal inspections should concentrate on visible signs of deterioration or damage to the system components. Items found to be defective must be replaced. Do not use components if inspection reveals an unsafe or defective condition. Record results of each inspection in the inspection and maintenance log in section 9.0 of this manual.

INSTALLED SYSTEMS: An inspection of the HLL system by a qualified person must be completed after the system is installed. The system must be periodically inspected by a qualified person when left installed for an extended period. Periodic formal inspections should be performed at least monthly, or more frequently when site conditions and use warrant. Inspections of installed systems should include the inspection steps listed in section 5.2.

ANNUALLY: A Qualified Person shall inspect the entire system including the anchorage points. Inspect for deterioration or damage. Items found to be defective must be replaced. Do not use components if inspection reveals an unsafe or defective condition. Record the results of each inspection in the Inspection and Maintenance Log section 9.0 of this manual.

BEFORE EACH USE: Before each use the user shall inspect the Zorbit HLL energy absorber, kit components and other system components. Inspect according to section 5.2. Items found to be defective must be replaced before using system.

5.2 INSPECTION STEPS:

Step 1. Inspect the turnbuckle for damage. Ensure sufficient threads are engaged into the turnbuckle body. Look for any cracks or deformities in the metal. Inspect metal components for rust or corrosion that may affect their strength or operation.

- Step 2.** Inspect the wire rope for rust, corrosion, broken wires, or other obvious faults. Inspect the HLL for proper tension. See sections 3.2 and 3.3. Inspect all hardware (fasteners, shackles, wire rope cable clips, etc.) securing the HLL assembly to ensure they are present and properly installed.
- Step 3.** Inspect the Zorbit HLL energy absorber for extension or deformities. There should be no tearing of the metal between holes in the Zorbit coiled section. Increase inspection frequency if the Zorbit is exposed to prolonged vibration. Extended Zorbit HLL energy absorbers must be removed from service and destroyed, or marked for training only. Inspect securing hardware for strength and function.
- Step 4.** Inspect Zorbit label. The label must be present and fully legible. See section 8.0. Replace label if missing or illegible.

IMPORTANT: *If this equipment is subjected to the forces of a fall arrest, it must be removed from service and destroyed, or returned to DBI/SALA for inspection or repair.*

5.3 If inspection reveals an unsafe or defective condition, remove unit from service and destroy, or contact DBI/SALA for possible repair.

5.4 USER EQUIPMENT: Inspect harnesses and energy absorbing lanyards or SRLs used with the HLL system according to manufacturer's instructions.

6.0 MAINTENANCE, SERVICE, STORAGE

6.1 The Zorbit kit components require no scheduled maintenance, other than repair or replacement of items found defective during inspection. See section 5.0. If components become heavily soiled with grease, paint, or other substances, clean with appropriate cleaning solutions. Do not use caustic chemicals that could damage system components.

6.2 USER EQUIPMENT: Maintain, service, and store user equipment according to manufacturer's instructions.

7.0 SPECIFICATIONS

7.1 MATERIALS:

Zorbit Energy Absorber: Stainless steel
 Bolts: Grade 5 or Grade 8 zinc plated steel
 Nuts: Zinc plated steel
 Shackles: Galvanized steel, 5,000 lbs. minimum tensile strength
 Thimbles: Galvanized steel
 Turnbuckle: Galvanized steel, 5,000 lbs. minimum tensile strength
 Cable Clips: Galvanized steel

7.2 ENERGY ABSORBER PERFORMANCE:

Peak Dynamic Pullout Load: 2,500 lbs.
 Average Dynamic Pullout Load: 2,000 lbs.
 Maximum Pullout: 48.5 inches
 Minimum Tensile Strength: 5,000 lbs.
 U.S. Patent No. 6,279,680

8.0 LABELING

8.1 This label must be present and fully legible:

⚠ WARNING

THIS HORIZONTAL LIFELINE ENERGY ABSORBER (EAHLL) MUST ONLY BE USED AS PART OF A DBI/SALA HORIZONTAL LIFELINE SUBSYSTEM (HLLSS), OR, AS PART OF A COMPLETE PERSONAL FALL ARREST SYSTEM INCORPORATING A HLLSS WHICH MAINTAINS A SAFETY FACTOR OF AT LEAST TWO, DESIGNATED, INSTALLED AND USED UNDER THE SUPERVISION OF A QUALIFIED PERSON. REFERENCE OSHA REGULATIONS. DO NOT USE AS A PERSONAL ENERGY ABSORBER. MANUFACTURER'S INSTRUCTIONS SUPPLIED WITH THIS PRODUCT AT TIME OF SHIPMENT MUST BE FOLLOWED. FAILURE TO DO SO COULD RESULT IN SERIOUS INJURY OR DEATH.



SPECIFICATIONS: MATERIAL - STAINLESS STEEL; PEAK DYNAMIC PULLOUT LOAD - 2500 LBS.; AVERAGE DYNAMIC PULLOUT LOAD - 2000 LBS.; MAXIMUM PULLOUT - 48.5 INCHES; ULTIMATE STRENGTH - 5000 LBS.; MODEL - 7401013
 PATENT PENDING
 USA: 3965 PEPIN AVE.
 RED WING, MN 55066
 (800) 328-6146
 CANADA: 260 EXPORT BLVD.
 MISSISSAUGA, ONTARIO
 CANADA, L5S 1Y9
 (800) 387-7484



9.0 INSPECTION AND MAINTENANCE LOG

SERIAL NUMBER:			
MODEL NUMBER:			
DATE PURCHASED:			DATE OF FIRST USE:

INSPECTION DATE	INSPECTION ITEMS NOTED	CORRECTIVE ACTION	MAINTENANCE PERFORMED
Approved By:			
Approved By:			
Approved By:			
Approved By:			
Approved By:			
Approved By:			
Approved By:			
Approved By:			
Approved By:			
Approved By:			
Approved By:			
Approved By:			
Approved By:			
Approved By:			
Approved By:			

This instruction applies to the following models:

7401013 7401019 7401033
7401016 7401031 7401035
7401018 7401032 7401037

Additional model numbers may appear on the next printing of these instructions



USA

3833 SALA Way
Red Wing, MN 55066-1837
Toll Free: 800-328-6146
Phone: (651) 388-8282
Fax: (651) 388-5065
www.capitalsafety.com

Canada

260 Export Boulevard
Mississauga, Ontario L5S 1Y9
Toll Free: 800-387-7484
Phone: (905) 795-9333
Fax: (905) 795-8777
www.capitalsafety.com

This manual is available for download at www.capitalsafety.com



Form: 5911863
Rev: E